

[Click on the Items Below or the Pictures to be Taken to That Page](#)

	Page	
Oils and Lubricants	2 - 6	
Lubrication Equipment (Grease & Oil)	7 - 32	
Fuel Equipment & Chemical Pumps	33 - 41	
Air Equipment	42 - 43	
Diaphragm Pumps & LED Light	44 - 45	
Hose Reels	46 - 48	
Protect Lanolin, Degreaser and Adhesive Products	51 - 64	
Adhesive Products Chemical Compatibility	65 - 69	
Compartment Storage Case & Cabinet / Frames	70	
Automotive Hoses	72 - 74	
Air Conditioning Hose and Fittings	75 - 76	
DEF (Diesel Exhaust Fluid) Adblue Tube & Fittings	76 - 77	
Cable Ties, Crimp Rings & Test Tags	79 - 80	
Hose Cleaning Equipment	81	
Thread Identification and Tool Kits	82 - 83	
Pressure Cleaner Components	84 - 91	



This page is part of a complete catalogue containing technical and safety data.
 All data must be reviewed when selecting a product.
 Pirtek reserve the right to change technical specifications without notice.

LUBRICANTS

MINERAL BASED OILS AND GREASES

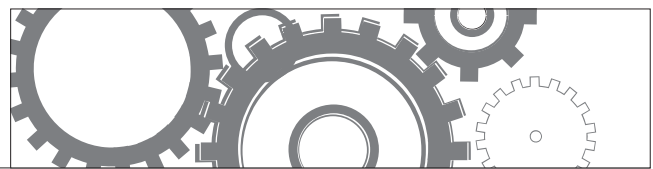

Hydraulic Oils:

- Pirtek supply popular commonly used hydraulic fluids
- Available in ISO Grades 46 and 68
- All oils incorporate advanced performance additives to combat rust, corrosion and wear
- Meet or exceed major manufacturer's requirements
- Handy 10 litre packs or 205 litre drums
- High Viscosity HVI types available upon request



Automotive Fluids:

- ATF Type D is a quality Automatic Transmission Fluid suitable for older style automatic transmissions and modern Power Steering systems available in a 5 litre pack
- For smaller power steering requirements, Pirtek offer a 350 ml pack of Power Steering Fluid
- For other specialist requirements, please consult Pirtek



Greases:

- NLGI No2 Lithium complex grease contains extreme pressure additive
- Recommended for extended lubrication intervals
- Suitable for wheel bearings (disc and drum brakes), chassis, construction and farm equipment
- Provides superior resistance to water wash out
- Good adhesive properties
- Has a smooth texture and is blue in colour

PIRTEK LUBRICATION PRODUCTS								
Product Code	Description	350 ml	450 gram	1 litre	5 litre	10 litre	20 litre	205 litre
VATFD-05	Type D Automatic Transmission Fluid 5 Lt				•			
VATFDX3-01	Type DX3 Automatic Transmission Fluid 1 Lt			•				
VATFDX3-05	Type DX3 Automatic Transmission Fluid 5 Lt				•			
VPS-350	Power Steering Fluid 350ml	•						
VEP2-450	Molyliith EP2 Grease 450 g (Box= 12 Units)		•					
VM-450	MoS ₂ Fortified Lithium Complex		•					
VHT46-10	Oil - Hydraulic Oil 46 X 10 Lt					•		
VHT46-20	Oil - Hydraulic Oil 46 X 20 Lt						•	
VHT46-205	Oil - Hydraulic Oil 46 X 205 Lt							•
VHT68-10	Oil - Hydraulic Oil 68 X 10 Lt					•		
VHT68-20	Oil - Hydraulic Oil 68 X 20 Lt						•	
VHT68-205	Oil - Hydraulic Oil 68 X 205 Lt							•

LUBRICANTS

MINERAL BASED OILS AND GREASES

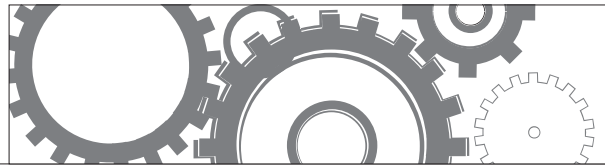

VHT46

HYDRAULIC OIL

ISO GRADE 46



Product Code	Description	Packaging Size
VHT46-10	Hydraulic Oil 46	10 litre
VHT46-20	Hydraulic Oil 46	20 litre
VHT46-205	Hydraulic Oil 46	205 litre

- Premium mineral based oil with quality additives for long life
- Good oxidation resistance, corrosion prevention, and anti-wear performance
- Recommended for use in mobile and industrial applications where either mild or severe operating conditions exist
- Ideal for general industrial equipment such as machine tools, rotary air compressors and enclosed gearboxes where extreme pressure additives are not required
- NB: **NOT** recommended for Lucas pumps with silver bearings
- Always refer to the Owner's Manual for recommended oil grade and change intervals
- Approvals: Vickers M-2950-S, 1-286-S
Cincinnati Milacron P68, P69, P70
DIN 51524 Part 2
US Steel 127, 136
Denison HF-1, HF-0

VHT68

HYDRAULIC OIL

ISO GRADE 68



Product Code	Description	Packaging Size
VHT68-10	Hydraulic Oil 68	10 litre
VHT68-20	Hydraulic Oil 68	20 litre
VHT68-205	Hydraulic Oil 68	205 litre

- Premium mineral based oil with quality additives for long life
- Good oxidation resistance, corrosion prevention, and anti-wear performance
- Recommended for use in mobile and industrial applications where either mild or severe operating conditions exist
- Ideal for general industrial equipment such as machine tools, rotary air compressors and enclosed gearboxes where extreme pressure additives are not required
- NB: **NOT** recommended for Lucas pumps with silver bearings
- Always refer to the Owner's Manual for recommended oil grade and change intervals
- Approvals: Vickers M-2950-S, 1-286-S
Cincinnati Milacron P68, P69, P70
DIN 51524 Part 2
US Steel 127, 136
Denison HF-1, HF-0

LUBRICANTS

MINERAL BASED OILS AND GREASES

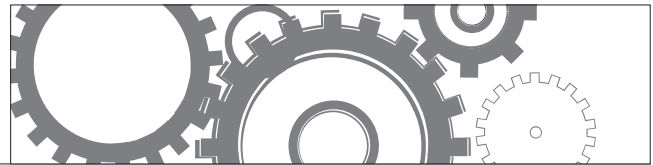

VATFD

AUTO TRANSMISSION FLUID TYPE D



Product Code	Description	Container Size
VATFD-05	Auto Transmission Fluid Type D	5 litre

- Can be used in all vehicles requiring a IID specification fluid
- Suitable for all GM vehicles up to 1993
- Can be used for in service fills on most popular vehicles
- Approvals: GM 6137M
Ford M2C 138-CJ
DB 236.6
DB 236.7

VATFDX3

AUTO TRANSMISSION FLUID TYPE DX-3



Product Code	Description	Container Size
VATFDX3-01	Auto Transmission Fluid Type DX-3	1 litre
VATFDX3-05	Auto Transmission Fluid Type DX-3	5 litre

- Formulated with premium base stocks and advanced additive technology to meet the challenging demands of an automatic transmission environment
- A high quality friction-modified lubricant
- Carries both GM and Ford approvals
- Responsive low temperature fluidity
- Benefits both electronically and hydraulically controlled transmissions
- Surpasses the requirements of Manufacturers specifying DEXRON® III
- Features greater friction stability to maintain consistent shift performance
- Meets new tests for wear and shudder resistance
- Resists thickening due to high temperature
- Approvals:
Dexron® III qualified
Ford M2C 138-CJ, M2C 166-H
Mercon
Caterpillar TO-2
HN 2105
Allison C4
GM 6297M

VPS

POWER STEERING FLUID



Product Code	Description	Container Size
VPS-350	Power Steering Fluid	350 ml

- Formulated to meet the stringent requirements of most power steering units
 - Prevents corrosion, oxidation and wear
 - Helps stop leaks
 - Keeps seals and O-Rings pliable
- PLEASE NOTE: This product is not suitable for all vehicles / power steering units.
Refer to vehicle owner's manual before application

LUBRICANTS

MINERAL BASED OILS AND GREASES

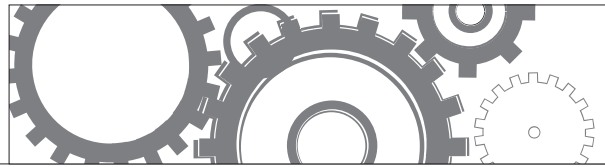

VM

ALL PURPOSE GREASE
LITHIUM COMPLEX WITH 3% MoS₂



Product Code	Description	Cartridge Size
VM-450	MoS ₂ Fortified Lithium Complex	450 gram

- Special long life grease for high load service conditions
- Fortified with extreme pressure additives
- Contains rust and corrosion inhibitors
- Tackiness adhesive additives prevent squeeze out under high loads
- Molybdenum Disulphide (MoS₂, 3%) incorporated to increase film strength
- Suited to all types of automotive, industrial and marine applications
- Meets NLGI No. 2 performance
- Grey / black in colour
- 5% MoS₂ version available upon request
- 12 Units per carton

VEP2

EXTREME PRESSURE GREASE
NLGI NO. 2 LITHIUM COMPLEX GREASE

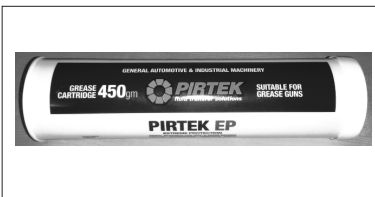

Product Code	Description	Cartridge Size
VEP2-450	Valplex EP Grease	450 gram

- Contains a non-lead extreme pressure (EP) additive
 - Contains rust and corrosion inhibitors
 - Suited to extended lubrication intervals of vehicle chassis points
 - Other applications:
 - Wheel bearings (drum or disc brake equipped) for all types of vehicles and equipment
 - Oscillating bucket pins and universal joints
 - Ball, roller and slow speed plain bearings under all service conditions
 - Meets NLGI No. 2 performance
 - Blue in colour
 - Smooth and tacky texture
 - 12 Units per carton
- CAUTION: DO NOT mix greases. Always thoroughly wash out bearings and housings before repacking

LUBRICANTS CLEANER AND DEGREASER

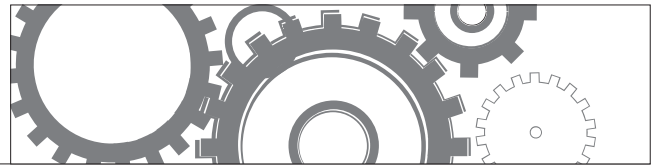

VABPC BRAKE PARTS CLEANER



Product Code	Description	Aerosol Size
VABPC-400	Brake Parts Cleaner	400 gram

- Quickly removes brake fluid, grease, oil and brake dust while leaving no residue
- The fast drying solvent helps dislodge surface dirt and oil to eliminate brake squeal
- Safe for use on electric motors, switches and distributor contacts during maintenance (do not apply to electrical components whilst they are in service)

VAD AUTO DEGREASER



Product Code	Description	Aerosol Size
VAD-400	SynPower Super Degreaser	400 gram

- An emulsifiable fluid with high solvency for removal of sludge and grime
- Clean engines, chassis, parts and concrete floors
- Simply spray on, allow to soak, and remove with jets of water
- Do not use on wet surfaces, since water will reduce the cleaning performance
- Available in bulk supply packs (5, 20, 205 litre) to special order

LUBE EQUIPMENT

GREASE, OIL, FUEL, WATER & AIR

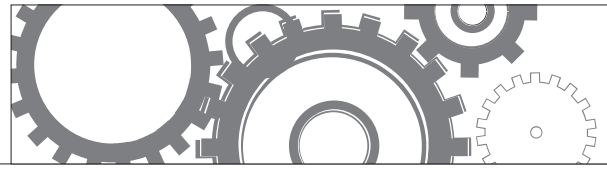

Description :

- Pirtek's extensive range of fuel, lubricant, chemical and solvent drum pumps facilitate quick and easy fluid transfer
- If you are aiming to source a cost effective means of transferring fluids out of drums, Pirtek will have the equipment to suit your needs to get the job done quickly

Description :

- The extensive range of Pirtek Greasing equipment facilitates the quick and efficient lubrication of plant and machinery, be it with the aid of simple grease nipples and grease guns or a multi-zoned, fully monitored lube system
- The new industry benchmark Series PL1 grease guns guarantee quick and easy greasing
- Strong technical back-up by our network will ensure that your lubrication problems are quickly and professionally solved



Product Range:

- 20 litre drum pumps
- 60 litre drum pumps
- 205 litre drum pumps
- Hand operated drum pumps
- Air operated drum pumps
- 12 volt, 24 volt, 240 volt drum pumps
- Synthetic or mineral based lubricant transfer drum pumps
- Kerosene, diesel fuel or petrol transfer drum pumps
- Transmission and brake fluid transfer drum pumps
- Chemical, acid or solvent drum pumps
- Grease transfer drum pumps
- Bulk tank pumps
- Air operated diaphragm pumps

Product Range:

- Grease nipples and grease nipple assortment kits
- Grease nipple extensions
- 450 gram grease guns
- Grease gun accessories
- 2.5kg, 20kg, 55kg and 180kg grease kits
- Grease control valves
- Grease swivels
- Grease hose reels
- Remote mount and manual grease kits
- Single, dual and multi line grease and oil systems



Applications:

- Ideal for automotive, agriculture, mining, timber, food & beverage and other primary industries
- Suit contractors and construction engineers
- Use in workshops, car dealerships, foundries etc

Applications:

- Industry application includes industrial, automotive, agricultural, transport, mining, marine, petrochemical, construction, food processing, steel and aluminium plants, forestry, milk and dairy, aviation and much more.
- * Please note when using grease gun couplers & grease gun hoses, the grease gun working pressure is rated to the lowest of the component's working pressure.

LUBE EQUIPMENT

GREASE GUNS

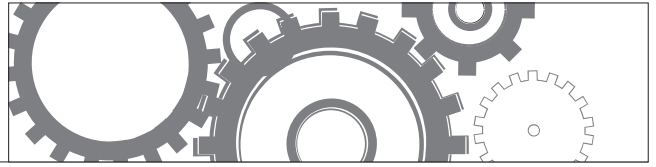

PL100

STANDARD GREASE GUN

LEVER ACTION



Product Code	Description	Grease Capacity
PL100	Standard Lever Action Grease Gun	450 gram

- Capacity : 450 gm
- Grease cartridge / suction fill.
- Construction : Sheet metal Grease Gun head fitted with Bulk Loader.
- 150 mm steel extrn. & standard 4 Jaw coupler
- Develops 6,000 PSI.
- Threaded : 1/8" BSPT
- Finish : Powder Coated Blue

PL101

HEAVY DUTY GREASE GUN

LEVER ACTION



Product Code	Description	Grease Capacity
PL101	Heavy Duty Lever Action Grease Gun	450 gram

- Capacity : 450 gm
- Grease cartridge / Suction fill / Bulk Fill.
- Construction : Aluminum Die Cast Grease Gun head fitted with bulk loader & auto air bleeder
- Features : Built-In Variable Stroke, super strong lever handle with rubber grip
- 150 mm steel extension & professional 4 Jaw coupler
- Develops 10,000 PSI
- Threaded : 1/8" BSPT
- Finish : Powder Coated Blue
- 1 gram/stroke

PL102

HEAVY DUTY GREASE GUN TO SUIT UNDERGROUND MINING

LEVER ACTION



Product Code	Description	Grease Capacity
PL102	Heavy Duty Lever Action Grease Gun Designed for Underground Coal Mining	450 gram

- Designed for Underground Coal Mining
- Capacity : 450 gm
- Grease cartridge / Suction fill / Bulk Fill.
- Construction : Zinc Die Cast Grease Gun head fitted with bulk loader & new air release valve
- Features : Built-In Variable Stroke, super strong lever handle with rubber grip
- 150 mm steel extension & professional 4 jaw coupler
- Develops 10,000 PSI
- Threaded : 1/8" BSPT
- Finish : Powder Coated Yellow
- 1 gram/stroke

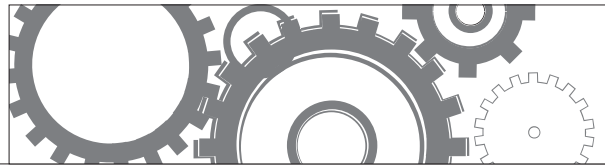

PL104

LEVER ACTION GREASE GUN

CLEAR TUBE, HEAVY DUTY



Product Code	Intended Use	Grease Capacity
PL104	Clear Tube Heavy Duty Lever Action Grease Gun	450 gram

- Capacity : 450 gm
- Grease cartridge / suction fill / Bulk Fill.
- Construction : Aluminum Die Cast Grease Gun head fitted with bulk loader & automatic air bleeder.
- Features : Built-In Variable Stroke, super strong lever handle with rubber grip
- 150 mm steel extrn. & professional 4 Jaw coupler
- Develops 10000 PSI.
- Threaded : 1/8" BSPT
- Finish : Clear Tube with Aluminium Ends
- 1 gram/stroke

PL105

MINI LEVER ACTION GREASE GUN



Product Code	Intended Use	Grease Capacity
PL105	Mini Lever Grease Gun	85 gram

- Capacity : 85 gm / 120 cc
- Grease cartridge / suction fill
- Construction : Aluminium Die Cast Grease Gun head fitted with steel block nut
- 150 mm steel extrn. & standard 4 Jaw coupler
- Develops 6000 psi
- Threaded : 1/8" BSPT
- Finish : Powder Coated Blue
- 0.55 gram/stroke

PL111

PISTOL GRIP ACTION HEAVY DUTY GREASE GUN



Product Code	Description	Grease Capacity
PL111	Pistol Grip Grease Gun	450 gram

- Capacity : 450 gm
- Grease cartridge / suction fill
- Construction : Aluminium Die Cast Grease Gun head fitted with automatic air bleeder.
- 300 mm Hose & professional 4 Jaw coupler.
- Develops 5000 PSI.
- Threaded : 1/8" BSPT
- Finish : Powder Coated Blue
- 0.50 gram/stroke

LUBE EQUIPMENT

GREASE GUNS

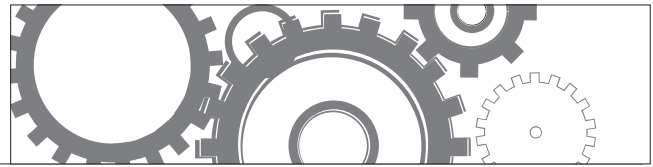

PL112

HEAVY DUTY GREASE GUN TO SUIT UNDERGROUND MINING PISTOL GRIP



Product Code	Description	Grease Capacity
PL112	Heavy Duty Pistol Grip Grease Gun designed for underground coal mining	450 gram

- Pistol Grip Grease Gun
- Capacity : 450 gm
- Grease cartridge / suction fill
- Construction : Zinc Die Cast Grease Gun head fitted with automatic air bleeder
- 300 mm Hose & professional 4 Jaw coupler.
- Develops 5000 PSI.
- Threaded : 1/8" BSPT
- Finish : Powder Coated Blue
- 0.50 gram/stroke

PL113

HEAVY DUTY GREASE GUN WITH VARIABLE OUTPUT PISTOL GRIP ACTION



Product Code	Description	Grease Capacity
PL113	Pistol Grip Grease Gun (Variable)	450 gram

- Pistol Grip Grease Gun
- Capacity : 450 gm
- Grease cartridge / suction fill / Bulk Fill
- Construction : Aluminium Die Cast Grease Gun head fitted with bulk loader valve.
- Features : Variable handle setting for High Pressure / high volume applications
- 300 mm High Pressure Hose & professional 4 Jaw coupler.
- Develops 7000 psi in High pressure setting & dispenses twice the amount of Grease compared to most other guns in high volume setting.
- Threaded : 1/8" BSPT
- Finish : Powder Coated Blue
- 0.90 gram/stroke

PL114

CLEAR TUBE HEAVY DUTY GREASE GUN PISTOL GRIP ACTION



Product Code	Description	Grease Capacity
PL114	Clear Tube Heavy Duty Pistol Action Grease Gun	450 gram

- Clear Tube Pistol Action Grease Gun
- Capacity : 450 gm
- Grease cartridge / suction fill
- Construction : Aluminium Die Cast Grease Gun head fitted with automatic air bleeder.
- 300 mm Hose & professional 4 Jaw coupler.
- Develops 5000 psi
- Threaded : 1/8" BSPT
- Finish : Clear Tube with Aluminium Ends
- 0.50 gram/stroke

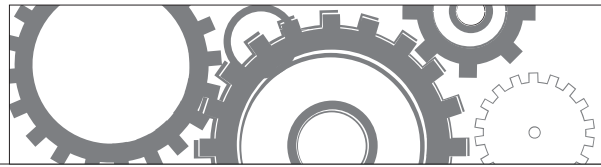

PL115

MINI GREASE GUN PISTOL GRIP ACTION



Product Code	Description	Grease Capacity
PL115	Mini Pistol Grease Gun with dual discharge ports (inline & 90 deg)	85 gram

- Capacity : 85 gm / 120 cc
- Grease cartridge / suction fill
- Construction : Aluminium Die Cast Grease Gun head fitted with steel block nut
- 100 mm steel extn. & standard 4 jaw coupler
- Develops 3500 PSI
- Threaded : 1/8" BSPT
- Finish : Powder Coated Blue
- 0.40 gram/stroke

PL120

AIR OPERATED HEAVY DUTY GREASE GUN CONTINUOUS ACTION



Product Code	Description	Grease Capacity
PL120	Continuous Action Air Operated Grease gun	450 gram

- Capacity : 450 gm
- Grease cartridge / suction fill / Bulk Fill
- Construction : Aluminium Die Cast Grease Gun head fitted with bulk loader valve.
- 150 mm steel extn. & professional 4 jaw coupler without ball check.
- Develops 4800 PSI.
- Threaded : 1/8" BSPT
- Finish : Powder Coated Blue
- Air inlet: 1/4" BSPT
- Pressure ratio 40:1
- 0.90 gram/shot
- Delivers 400 grams/minute
- Max air inlet pressure 3-8 bar (40-120 psi)

LUBE EQUIPMENT

GREASE GUN ACCESSORIES

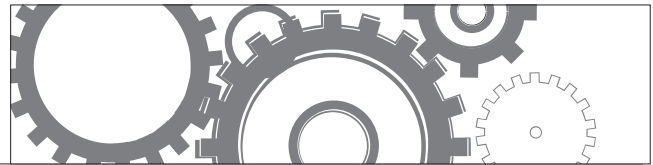

PL140

PROFESSIONAL GREASE GUN COUPLER 4 JAW



Product Code	Description	Pressure Rating
PL140	Professional Grease Gun Coupler	6,000 psi

- Professional 4 Jaw Coupler with Ball Check
- 6000 psi / 415 Bar
- For Hand Operated Grease Guns
- 15mm diameter
- 1/8" BSPT

PL141

HEAVY DUTY GREASE GUN COUPLER 4 JAW



Product Code	Description	Pressure Rating
PL141	Heavy Duty 4 Jaw Coupler	10,000 psi

- Heavy Duty 4 Jaw Coupler with Ball Check
- 10,000 psi / 690 Bar
- For Hand & Air Operated Grease Guns
- 17mm diameter
- 1/8" BSPT

PL142

GREASE GUN COUPLER 90 DEGREE

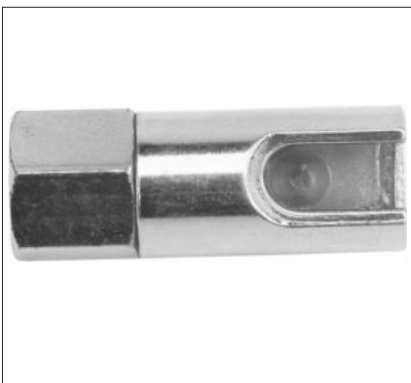

Product Code	Description	Pressure Rating
PL142	90 Degree Coupler without Ball Check	1,000 psi

- Hydraulic Coupler 90 Degree without Ball Check
- 1,000 psi / 69 Bar
- For hand operated Grease Guns
- 1/8" BSPT

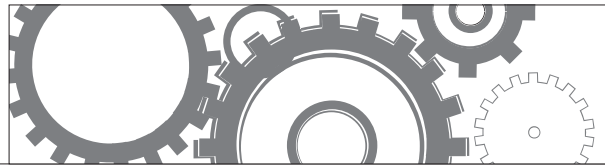

PL143

HYDRAULIC COUPLER

360° SWIVEL



Product Code	Description	Pressure Rating
PL143	Hydraulic Coupler 360 Deg Swivel	7,000 psi

- Hydraulic Coupler 360 deg, locks at any 45 deg position
- 3 Jaw with Ball Check
- 7,000 psi/483 bar
- For hand operated Grease Guns
- 1/8" BSPT

PL144 & PL145

PUSH ON BUTTON HEAD COUPLERS

SUIT 16 mm & 20 mm BUTTON HEADS



Product Code	Description	Pressure Rating
PL144	Push On 16 mm Button Head Coupler	6,000 psi
PL145	Push On 22 mm Button Head Coupler	6,000 psi

- Push On Button Head Coupler for 16 mm and 22 mm Button Head Fittings.
- 6,000 psi/413 Bar
- 1/8" BSPT

PL146

GREASE ACCESSORY KIT

QUICK CONNECT 7 PCE

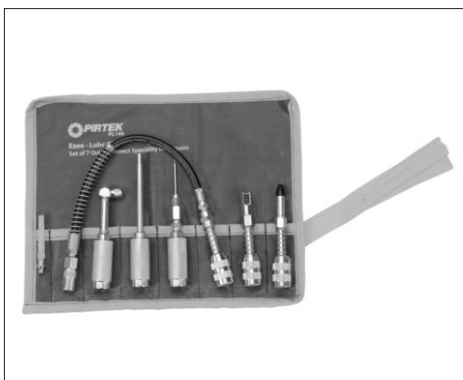

Product Code	Description	No. of Pieces
PL146	Quick Connect Grease Gun Accessory Kit	7

- 7 pc Quick Connect Grease Guns accessory Kit Including :-
- Professional Recessed Lube Adaptor - 1000 PSI W.P
- Grease Injector Needle s/s 38 mm long - 1000 PSI W.P
- Professional 90 deg Angle Lube Adaptor - 1000 PSI W.P
- Professional Narrow Needle Nose Adaptor - 1000 PSI W.P
- Jaw Type Coupler to Seal Off Dispenser - 1000 PSI W.P
- Regular Coupler to Right Angled Coupler - 1000 PSI W.P
- Quick Connect Hose - 3500 PSI W.P

LUBE EQUIPMENT

GREASE GUN ACCESSORIES

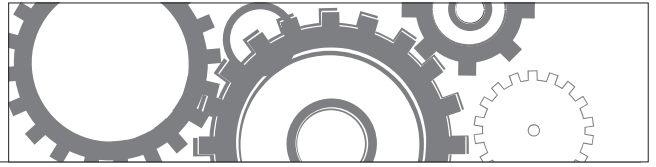

PL150 - PL155

GREASE GUN HOSES

STANDARD & HIGH PRESSURE



Product Code	Standard Pressure (Hand Operated Guns) 240 Bar / 3,500 psi WP (11,600 psi BP)			High Pressure (Hand and Air Operated Guns) 400 Bar / 5,800 psi WP (13,775 psi BP)		
	Length mm			Length mm		
	200	300	450	300	450	700
PL150	•					
PL151		•				
PL152			•			
PL153				•		
PL154					•	
PL155						•

- High Pressure hoses are ideal for cold weather use
- All threads are 1/8" BSPT
- Standard Pressure Hose (OD = 8.5 mm, ID = 3.6 mm)
- High Pressure Hose (OD = 10.8 mm, ID = 4.1 mm)

PL157

GREASE GUN EXTENSION

FLEXIBLE / RIGID COMBO

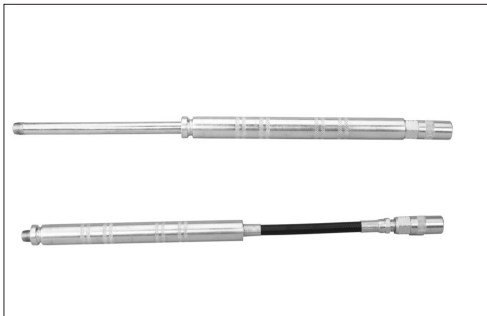

Product Code	Description	Pressure Rating
PL157	Flexible / Rigid Grease Gun Extension	5,000 psi

- 5000 psi / 345 Bar
- Converts Rigid Extn. To Flex. & vice versa
- Extends to 330 mm overall length

PL158

GREASE GUN EXTENSIONS

BENT / STRAIGHT 2 PIECE PACK



Product Code	Description	Pressure Rating
PL158	Combo Straight and Bent Grease Gun Rigid Extensions	6,000 psi

- Combo Pack
- Includes one 150 mm Bent Steel Extn. & one 100 mm Straight Steel Extn.
- Threaded 1/8" BSPT
- 6000 psi / 413 Bar

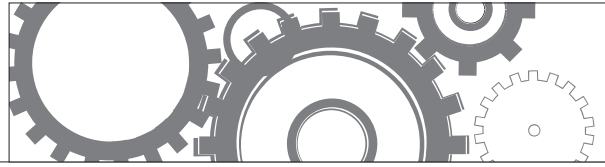

PL159

GREASE GUN EXTENSION IN LINE SWIVEL JOINT



Product Code	Description	Threads
PL159	Grease Gun Extension Inline Swivel	1/8" BSPT Male x 1/8" Female

- Grease Gun Extension Swivel
- 1/8" BSPT Male x 1/8" BSPT Female
- 3000 psi / 240 Bar
- All steel construction

PL161

GREASE GUN HOLDER SUITS HIGH VIBRATION LOCATIONS



Product Code	Description	To Suit
PL161	Heavy Duty Manual Grease Gun Holder	Suits 400 and 450 gram capacity guns

- Heavy Duty Grease Gun Holder for high vibration environment
- Works with both 400 gm capacity Grease Guns as well as 450 gram capacity Grease Guns
- All Steel construction with a 4 bolt design for easy & secure mounting

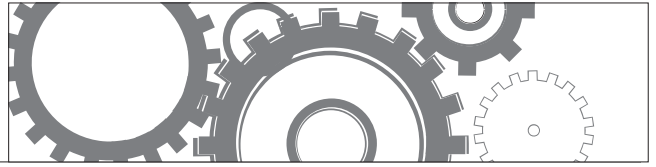

PL162
LED LIGHT ATTACHMENT
FOR GREASE GUNS



Product Code	Description	Includes
PL162	LED Grease Gun Light	Batteries, Mounting Clip

- LED Grease Gun Light
- Complete with batteries
- Includes mounting clamp that fits on Grease Gun Steel extension as well as flex hoses

PL163
BULK LOADER / FILLER NIPPLE
(SPARE PART)



Product Code	Description	Note
PL163	Bulk Loader / Filler Nipple	Spare Part

- Bulk Loader / Filler Nipple (Spare)
- (Spare part for Cartridge Grease Gun)
- 0.9mm diameter
- 1/8" BSPT

PL164
AIR RELEASE VALVE
(SPARE PART)



Product Code	Description	Note
PL164	Air Release Valve	Spare Part

- Air Release Valve (Spare)
- (Spare part for Cartridge Grease Gun)
- Vents air pockets in grease guns efficiently
- 1/8" BSPT

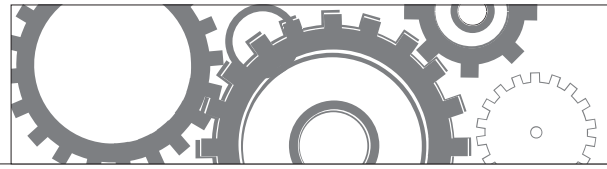

PL170 - PL178

GREASE NIPPLES



- Head profile as per SAE J534 and DIN 71412 for Metric Fittings
- Heat treated Grease End & spring on ball check types
- Zinc plating exceeds ASTM B117
- Super strong rolled threads
- Salt Spray Tested
- Tested for operating, opening & back pressure

Product Code	Description	BSPT			NPT			UNF			SAE			Metric		
		Str.	45°	90°	Str.	45°	90°	STR	45°	90°	STR	45°	90°	Str.	45°	90°
PLGN1-1/8-28	GREASE NIPPLE 1/8 BSPT	1/8														
PLGN4-1/8-28	GREASE NIPPLE 45° 1/8 BSPT		1/8													
PLGN9-1/8-28	GREASE NIPPLE 90° 1/8 BSPT			1/8												
PLGN1-1/4-19	GREASE NIPPLE 1/4 BSPT	1/4														
PLGN1-1/4-28UNF	GREASE NIPPLE 1/4 UNF							1/4								
PLGN1-6X1	GREASE NIPPLE 6X1 METRIC													M6		
PLGN1-8X1	GREASE NIPPLE 8X1 METRIC													M8		
PLGN1-1/8-27	GREASE NIPPLE 1/8 NPT				1/8											
PLGN1-1/4-18	GREASE NIPPLE 1/4 NPT				1/4											
PLGN4-1/4-19	GREASE NIPPLE 45° 1/4 BSPT		1/4"-19													
PLGN9-1/4-19	GREASE NIPPLE 90° 1/4 BSPT			1/4"-19												
PLGN4-1/8-27	GREASE NIPPLE 45° 1/8 NPT				1/8"-27											
PLGN4-1/4-18	GREASE NIPPLE 45° 1/4 NPT				1/4"-18											
PLGN9-1/8-27	GREASE NIPPLE 90° 1/8 NPT				1/8"-27											
PLGN9-1/4-18	GREASE NIPPLE 90° 1/4 NPT				1/4"-18											
PLGN1-1/4-28SAE	GREASE NIPPLE 1/4 SAE										1/4"-28					
PLGN4-1/4-28SAE	GREASE NIPPLE 45° 1/4 SAE										1/4"-28					
PLGN9-1/4-28SAE	GREASE NIPPLE 90° 1/4 SAE											1/4"-28				
PLGN1-10X1	GREASE NIPPLE 10X1 METRIC													M10x1		
PLGN9-6X1	GREASE NIPPLE 90° 6X1 METRIC															M6x1
PLGN9-8X1	GREASE NIPPLE 90° 8X1 METRIC															M8x1
PLGN9-10X1	GREASE NIPPLE 90° 10X1 METRIC															M10x1
Stainless Steel		BSPT			NPT			UNF			SAE			METRIC		
		STR	45°	90°	STR	45°	90°	STR	45°	90°	STR	45°	90°	STR	45°	90°
PLGN1SS-1/8-28	GREASE NIPPLE S/S 1/8 BSPT	1/8"														
PLGN9SS-1/8-28	GREASE NIPPLE S/S 90° 1/8 BSPT			1/8"												
PLGN4SS-1/8-27	GREASE NIPPLE S/S 45° 1/8 NPT				1/8"-27											
PLGN9SS-1/8-27	GREASE NIPPLE S/S 90° 1/8 NPT				1/8"-27											
PLGN1SS-1/4-28SAE	GREASE NIPPLE S/S 1/4 SAE										1/4"-28					
PLGN4SS-1/4-28SAE	GREASE NIPPLE S/S 45° 1/4 SAE										1/4"-28					
PLGN9SS-1/4-28SAE	GREASE NIPPLE S/S 90° 1/4 SAE			1/8"								1/4"-28				

LUBE EQUIPMENT

GREASE FITTINGS

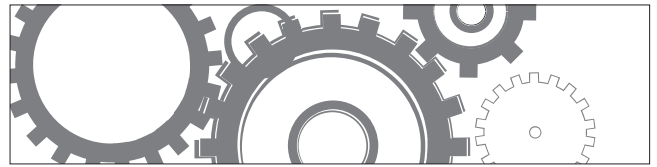

PL180 - PL185

GREASE NIPPLE ASSORTMENT - KITS



Product Code	Description	No. of Pieces
PL180	BSPT Assortment	50
PL182	Metric Assortment	80
PL184	SAE / NPT Assortment	80
PL185	St'less Steel SAE / NPT Assortment	40

BSPT Kits

- (PL180)
 1/8"-28 20 Straight
 1/8"-28 5 45°
 1/8"-28 5 90°
 1/4"-19 10 Straight
 1/4"-19 5 45°
 1/4"-19 5 90°

Metric Kits

- (PL182)
 M6x1 20 Straight
 M6x1 10 90°
 M8x1 15 Straight
 M8x1 10 90°
 M10x1 15 Straight
 M10x1 10 90°

SAE / NPT Kits

- (PL184)
 NPT 1/8"-27 25 Straight
 NPT 1/8"-27 10 45°
 NPT 1/8"-27 10 90°
 SAE 1/4"-28 15 Straight
 SAE 1/4"-28 10 45°
 SAE 1/4"-28 10 90°
St'less Steel SAE / NPT Kits
 (PL185) Grade 303 s/steel
 NPT 1/8"-27 10 Straight
 NPT 1/8"-27 5 45°
 NPT 1/8"-27 5 90°
 SAE 1/4"-28 10 Straight
 SAE 1/4"-28 5 45°
 SAE 1/4"-28 5 90°

PL190 & PL191

GREASE NIPPLE EASY OUT TOOL



Product Code	Description	Size
PL190	Grease Fitting Easy Out Tool 1/8"-27	Small
PL191	Grease Fitting Easy Out Tool 1/4"-28	Large

- PL190 - Small type hex size 5/16" & 3/8" (9mm)
- PL191 - Large type hex size 3/8" (9mm) & 7/16" (11mm)

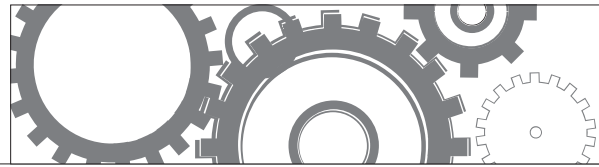

PL192

GREASE FITTING UNBLOCKER



Product Code	Description	Note
PL192	Grease Fitting Unblocker	Ideal for Toolbox

- Opens clogged grease fittings and loosens hardened grease joints
- Excellent for maintaining and protecting bearings, control arms, joints, king pins, etc.
- Tool has an all steel construction & is designed to be tapped with a hammer to force a light viscosity oil through the tool into the coupler & finally into the grease joint, breaking up and removing dirt and debris
- Built-In Hand Guard for added safety in use
- Flexible hose attachment reaches fittings in difficult areas
- Comes complete with grease coupler for connection onto the grease fitting and 2 spare seals for replacing the piston seals as they wear out

PL193

GREASE FITTING CAPS

AVAILABLE IN 3 COLOURS



Product Code	Description	Pack Size
PL193R	Red Grease Fitting Cap	50
PL193Y	Yellow Grease Fitting Cap	50
PL193B	Black Grease Fitting Cap	50

- Plastic Caps for Grease fittings are an easy way to keep contaminants out.
- These additionally help in colour coding the greasing points based on frequency of greasing or type of grease
- Designed with an inbuilt collar, these are most convenient in use & fit directly onto the greasing end of the fitting
- Made from a special plastic, these adjust to minor variations in fitting head diameter, as well as variations in temperature & practically fit all standard fittings designed for use with jaw type couplers
- Available in Black, Yellow and Red as standard with other colours that can be custom manufactured
- Sold in packs of 50

PL194

GREASE FITTING THREAD TESTER

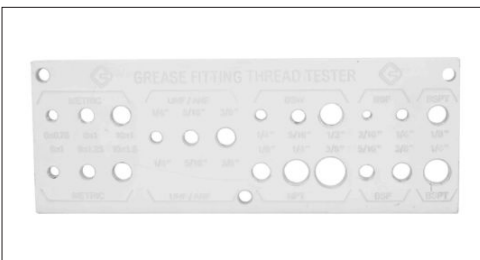

Product Code	Description	Note
PL194	Grease Fitting Thread Tester	Ideal for Toolbox

- Great tool box accessory to sort out mixed fittings
- Aluminium construction with mounting holes
- Dimensions: 75mm x 207 mm
- Checks the tabulated 21 popular thread sizes

NPT	1/8"	1/4"	3/8"	
Metric	M6 X 1	M6 X 0.75		
Metric	M8x1	M8x1.25		
Metric	M10x1	M10x1.5		
BSPT	1/8"	1/4"		
UNF/ANF	1/4"	5/16"	3/8"	
BSW	1/4"	5/16"	1/2"	3/8"
BSF	3/16"	1/4"	5/16"	

LUBE EQUIPMENT

BULK GREASE EQUIPMENT

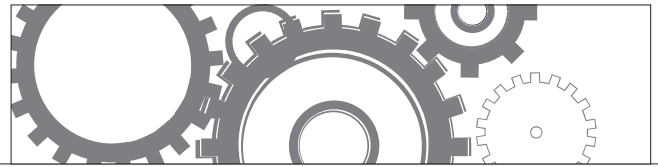

PL300

20 KG GREASE GUN LOADER PUMP



Product Code	Description	Dimensions
PL300	20 kg Grease Gun Loader Pump	Suits 310 mm Drum Covers

- Easy to use Grease filling solution to load bulk or combination grease guns from bulk grease pails
- Delivers 28 grams per stroke
- No mess or waste. Full economy in buying bulk grease
- Complete unit includes zinc plated pump with zinc die cast pump head and cast aluminium adjusting flange, drum cover follower plate & female loader fitting
- Brass piston rings mounted on zinc die cast piston for minimal wear
- Includes follower plate with rubber lining for use with tapered drums

RECOMMENDED USE

For Light & self Collapsing Grease up to and including NLGI 2

PL305

FOOT OPERATED GREASE PUMP



Product Code	Description	Stroke Capacity
PL305	10 kg Grease Kit	2 grams per stroke

- High Pressure Portable Grease Pump for quick effortless greasing in everyday lubrication such as greasing of excavators & other earth moving equipment, agricultural equipment, automotive etc.
- Hands free operation; pump operates using the Foot Lever, which greatly reduces effort & allows high pressure greasing with highest comfort
- Can be operated by hand when under low machinery
- Economical, pump is operated by a single person & uses low cost bulk grease
- Designed with all moving parts submerged in the same grease which needs to be pumped, thereby staying lubricated at all times
- Moving parts create wave action in grease, auto removing air pockets & eliminating the use of a Follower plate
- Pump delivers over 2 gms of grease per stroke & develops 8,700 psi (600 bar)
- Supplied with 2 metres of 1/4" hose
- Works with NLGI 1, 2 & 3 Greases

PL310 & PL312

AIR OPERATED 50:1 RATIO GREASE PUMP (PUMP ONLY)

SUIT 180 KG & 20 KG DRUMS



Product Code	Description	To Suit
PL310	50:1 Ratio Air Assisted Grease Pump	Suits 180 kg Drums
PL312	50:1 Ratio Air Assisted Grease Pump	Suits 20 kg Drums

- Suitable for use with 180 kg and 20 kg drums (PUMP ONLY)
- Air Inlet 1/4" (Female), Pump Outlet 1/4" (Female) BSPT
- Working Pressure 30 - 150 psi.
- World-class Industrial High Pressure Grease pump with guaranteed performance & hassle free operation
- Pump dispenses Grease at pressures up to 50 times the Air inlet pressure
- Designed to work in tough conditions
- Ideal for use in Industry, workshop, farm, construction or as part of the Mobile Grease system
- All metal construction, fully CNC machined with hardened wear resistant moving parts
- Reciprocating piston operated 2.5" (63 mm) dia. Air Motor
- Fitted with strainer at suction tube inlet for clean grease to the bearing
- Flow - 1.1Kg per minute free flow (dependant on grease properties & temperature)
- Maximum pressure at air inlet 2-10 bar (30-150 psi)



PL311

AIR OPERATED 50:1 GREASE RATIO PUMP (COMPLETE KIT)
SUILTS 180 KG DRUMS



Product Code	Description	To Suit
PL311	50:1 Ratio Air Assisted Grease Pump	Suits 180 kg Drums

- Suitable for use with 180 kg drums
- Air Inlet 1/4" (Female), Pump Outlet 1/4" (Female) BSPT
- Working Pressure 30 - 150 psi.
- World-class Industrial High Pressure Grease pump with guaranteed performance & hassle free operation
- Pump dispenses Grease at pressures up to 50 times the Air inlet pressure
- Designed to work in tough conditions
- Ideal for use in Industry, workshop, farm, construction or as part of the Mobile Grease system
- All metal construction, fully CNC machined with hardened wear resistant moving parts
- Reciprocating piston operated 2.5" (63 mm) dia. Air Motor
- Fitted with strainer at suction tube inlet for clean grease to the bearing
- Complete with 2 mtr of 1/4" of high pressure hose, Z Swivel, control valve, 24-1/2" drum cover & follower plate
- Delivers 1.1 kg per minute Free Flow - (Dependant on grease properties and temperature)
- Maximum air inlet pressure 2-10 bar (30-150 psi)

PL315

AIR OPERATED 50:1 GREASE RATIO PUMP
MOBILE 30 KG GREASE KIT



Product Code	Intended Use	Discharge Rate
PL315	Air Operated 30 kg Mobile Grease Kit	1.1 kgs per minute

- World-class Industrial High Pressure Grease pump with guaranteed performance & hassle free operation
- Pump dispenses grease at pressures up to 50 times the Air inlet pressure.
- Designed to work in tough conditions - ideal for use in Industry, workshop, farm, construction or as part of a Mobile Grease system
- All metal construction, fully CNC machined with hardened wear resistant moving parts
- Reciprocating piston operated 2.5" (63 mm) dia. Air Motor
- Fitted with strainer at suction tube inlet for clean grease to the bearing
- Supplied complete with built-in Steel Drum, wheels & pull handle, Drum Cover, rubber lined Follower Plate, 2 meters of high pressure 1/4" Grease Hose, Z swivel & professional Grease Control Valve
- Maximum air inlet pressure 2-10 bar (30-150 psi)

PL320 & PL321

FOLLOWER PLATES
SUIT 20 KG / 180 KG DRUMS



Product Code	Intended Use	Dimensions
PL320	20 kg Drum Follower Plate	288 mm OD, 29.5 mm Grommet
PL321	180 kg Drum Follower Plate	602 mm OD, 29.5 mm Grommet

- Rubber Lined Follower Plate

LUBE EQUIPMENT
BULK GREASE EQUIPMENT

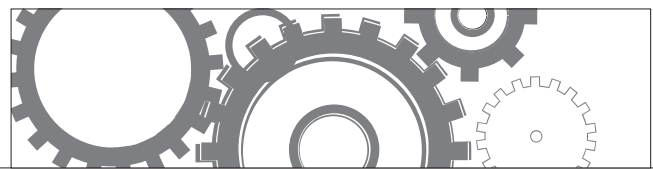

PL322 & PL324
DRUM COVERS
SUIT 20 KG / 180 KG DRUMS



Product Code	Intended Use	Description
PL322	20 kg Drum Cover	Drum Cover Complete
PL324	180 kg Drum Cover	Drum Cover Complete

PL325 & PL326
REPAIR KITS *
AIR MOTOR AND PUMP CHAMBER KITS

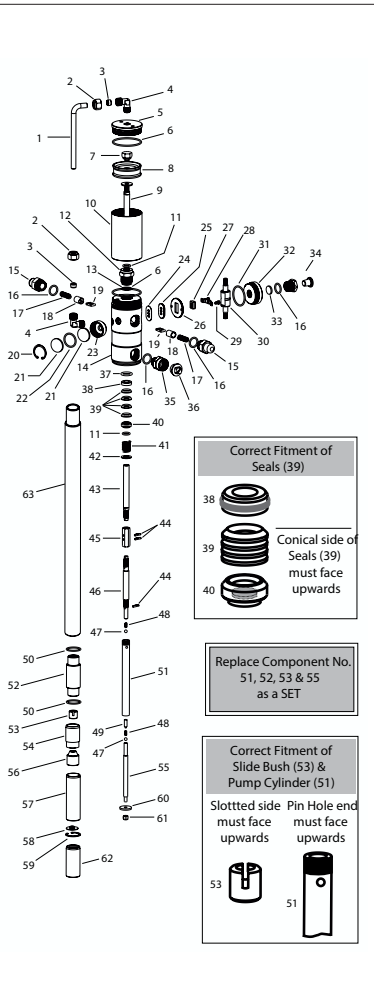

Product Code	Intended Use	Drum Capacity
PL325	Air Motor Kit To Suit PL310/PL311 Pumps	180 kg Drums
PL326	Pump Chamber Kit To Suit PL310/PL311 Pumps	180 kg Drums

KIT PART NO.	KIT DESCRIPTION	CONSTITUENT PART NO.	PART DESCRIPTION	REFERENCE NO. FROM PARTS DRAWING	QTY. PER KIT
PL325	DRIVE SECTION KIT	SR/B/RP	Sealing Ring	3	2
		BEND/90/RP	Bend	4	2
		ORG/BS141	O Ring	6	2
		ORG/BS614	O Ring	11	2
		ORG/BS617	O Ring	16	4
		ORG/BS121	O Ring	22	1
		SEL/P/RP	Paper Seal	24	1
		SET/RP	Seat	25	1
		SLD/NY/RP	Nylon Slider	27	1
		CLP/RP	Clip	28	1
		SCR/M4/RP	Self Tapping Screw	29	2
		ORG/BS129	O Ring	31	1
		ORG/BS614	O Ring	37	1
		GUD/SEL/RP	Slider Guide	38	1
		SEAL/RP	Seal	39	4
		SU/SEL/RP	Seal Support	40	1
		PL326	PUMPING SECTION KIT	ROD/CNR/S/RP	Connecting Rod
SSP/3/0.6/15.3	Slotted Spring Pin			44	3
SB/7-32	Steel Ball (7/32")			47	2
SPR/NR/RP-G	Non Return Spring			48	2
VLV/RP-G	Valve			49	1
ORG/BS812	O Ring			50	2
CYL/RP-G	Pump Cylinder			51	1
CPL/TOP/RP-G	Top Coupler			52	1
BSH/SLD/RP-G	Slide Bush			53	1
ROD/PST/RP-G	Piston Rod			55	1
BSH/RP-G	Guide Bush			56	1
WSR/PST/RP-G	Piston Washer	60	1		
NN/M6/RP-G	Nyloc Nut	61	1		
IC/FLT/RP-G	Filter Cap	62	1		

* REFER TO THE INDIVIDUAL INSTALATION, OPERATION & MAINTENANCE MANUALS

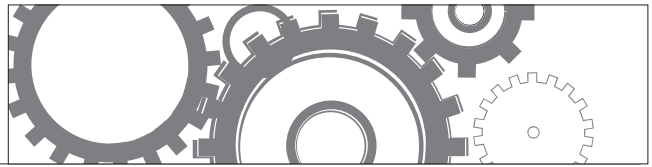

PL330

GREASE CONTROL VALVE



Product Code	Contains	Inlet
PL330	Control Valve with 150mm bent extension	1/4" BSPT Female Inlet Thread

- Premium quality grease control valve for use with air operated grease pumps
- Provides continuous grease flow with trigger fully pressed
- Steel construction for durability & longevity
- Ergonomically designed pistol handle
- Comes complete with 6" steel extension & heavy duty coupler
- Available as valve only
- Suited to underground coal mining (all steel construction)
- 7500 psi / 517 Bar
- Can be fitted with Z-Swivel (Refer PL340)

PL331

BOOSTER GREASE CONTROL VALVE



Product Code	Contains	Inlet
PL331	Control Valve with 150mm bent extension	1/4" BSPT Female Inlet Thread

- Heavy Duty Grease control valve with built-in pressure boost mechanism.
- Provides continuous flow with pistol handle fully pressed
- Pressure boost achieved through repeated actuation of the pistol handle. Boosts line pressure from 6,000 PSI (400 BAR) to 10,000 PSI (690 BAR); extremely useful to unblock frozen grease fittings
- Heavy Duty steel construction, provides durability & longevity
- Ergonomically designed pistol handle
- Available as valve only
- Comes complete with 6" (150 mm) steel extension & coupler
- Suited to underground coal mining (all steel construction)
- Can be fitted with Z-Swivel (Refer PL340)

PL332

GREASE CONTROL VALVE INTEGRATED DIGITAL METER



Product Code	Description	Inlet
PL332	Grease Control Valve - Electronic	1/4" BSPT Female Inlet Thread

- Premium quality Grease Control valve, for use with air operated grease pumps
- Built-In High Accuracy Digital Grease Meter for dispensing exact amount of grease
- Ability to measure amount of grease dispensed prevents both over & under lubrication & is invaluable in saving bearing failures
- Provides continuous grease flow, with trigger fully pressed
- Steel construction, provides durability & longevity. Meter uses oval gear technology
- Ergonomically designed pistol handle
- Comes complete with 6" (150mm) steel extension & heavy duty coupler
- Max pressure 8,000 psi / 550 Bar
- Unit of measure = Kgs
- Batteries included

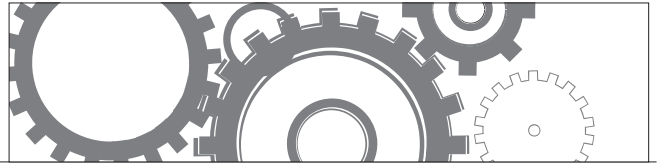

PL333

IN-LINE DIGITAL GREASE METER



Specifications		
Control Valve Type	Continuous flow	
Meter Type	Digital Oval Gear	
Grease Flow	0.2-5.5lb / Min	0.1 to 2.5kg / Min
Max. Working Temperature Range	7,500 PSI	517 BAR
Working Temperature Range	-10°C to 60°C	14°F to 140°F
Unit of Measurement	KG / GMS / OZ / LBS	
Resolution	0.10 OZ.	0.10 GMS
Accuracy	±3%	
Resettable Batch Total	9,999	
Cumulative Total	999999	
Battery Type	2 x 1.5V Size N	
Inlet/Outlet	1/8" NPT Female	

PL340

GREASE 'Z' SWIVEL



Product Code	Contains	Threads
PL340	10,000 psi 'Z' Swivel	1/4" BSPT Male / Female Threads

- Installed between the delivery hose & grease control valve, swivels permit easy handling of control valves and prevent damage to hose caused by twisting
- Swivels have a heavy duty steel construction with ball bearings for smooth operation and free unrestricted movement
- The swiveling joints are hardened for durability & wear resistance

PL341

HYDRAULIC COUPLER 3 JAW COUPLER FOR GREASE CONTROL VALVES



Product Code	Description	Pressure Rating
PL341	3 Jaw Coupler with Ball Check	7,500 psi / 517 Bar

- Recommended for use with grease control valves
 - Hardened coupler body & all internal parts withstand high dynamic pressures without deformation
 - Fully hardened reversible spring steel jaws for extended service life
 - Hexagonal nut for easy tightening
 - 100% pressure tested
- 1/8" BSPT (female)





PL400

LEVER ACTION DRUM PUMP TO FIT 20 - 205 LITRE DRUMS



Product Code	Description	Capacity
PL400	Lever Action Drum Pump with NBR seals	300 ml per stroke

- Most popular pump design, engineered for professional use
- Powder coated steel pump body with ribbed section aluminum die cast pump head for maximum strength
- Built-in 1.1/2" & 2" bung for use on drums with either openings
- Plated steel lever handle with rubber grip for convenience
- Wear resistant Brass piston rings fitted onto zinc die cast piston
- Comes complete with curved metal spout & telescopic suction tube for use on 50 litre – 205 litre barrels
- Suited to oil based fluids, heating oils, motor oils, heavy and light oils, kerosene and diesel
- Not suited for water based fluids, solvents, acids, anti-freeze, or petrol

PL401

CLEAR TUBE LEVER ACTION DRUM PUMP TO FIT 20 - 205 LITRE DRUMS



Product Code	Description	Capacity
PL401	Clear Tube Lever Action Drum Pump	300 ml per stroke

- Professional Barrel pump for pumping all types of oils
- Tough & Impact Resistant Polycarbonate tube with die cast aluminum adaptors
- Ribbed section Aluminum Die Cast pump head for maximum strength
- Nitrile Rubber Piston rings for smooth operation
- Built-in 1-1/2" & 2" bung for use on drums with either opening
- Delivers 300 ml (10 oz.) per stroke
- Comes complete with curved metal spout & telescopic suction tube for use on 50 litre – 205 litre barrels
- Suited to oil based fluids, heating oils, motor oils, heavy and light oils, kerosene and diesel
- Not suited for water based fluids, solvents, acids, anti-freeze, or petrol
- Transparent barrel facilitates monitoring of lubricant cleanliness

PL402

PROFESSIONAL ROTARY DRUM PUMP TO FIT 20 - 205 LITRE DRUMS



Product Code	Description	Capacity
PL402	Professional Rotary Drum Pump	250 ml per turn

- Most popularly used pump worldwide.
- The Pirtek version of the Rotary Pump is superior to any other with features such as Dual Directional Operation which allows the pump to both empty, as well as refill containers
- Extremely Heavy Duty & rugged weighing 6.6 kgs (14.5 lbs)
- Pump body is sturdy cast iron with precisely machined cast iron vanes for better draw & smoother delivery
- Pump seals are made from Viton
- Fits 50 litre to 205 litre barrels
- 1" threaded inlet at base of pump housing
- Comes complete with suction tube, 2" cast iron bung nut & discharge spout
- NOTE: Add 30 ml of the fluid to be pumped into the pump outlet to assist priming when transferring low viscosity fluids such as kerosene or diesel

LUBE EQUIPMENT

MANUAL OIL PUMPS AND GUNS

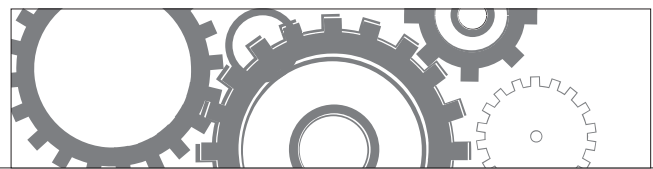

PL404

EZEE FLOW DOWNSTROKE PUMP FOR 20 LITRE DRUMS



Product Code	Description	Capacity
PL404	Ezee Flow Downstroke Pump	18 strokes per litre (56 ml per stroke)

- Versatile pump, engineered for trouble free use on 5 gallon / 20-25 litre containers with plastic pull out (Rieke® spout) or 2" external threads
- Downstroke operation with fluid discharge when pushing the handle down. Enhanced ease of use & reduced fatigue especially when pumping heavy fluids. It additionally reduces pull out stress on the pump bung
- Heavy duty steel suction tube, with the pump head made from high density polyethylene. Pump head incorporates nozzle holder & option to drain back over flown fluid into the container
- Interchangeable bung adaptors. The standard bung adaptors can be slid over the pump, when using on containers with external threading. Alternatively, when using the pump on pails with plastic pull out Rieke® spout, the other bung adaptor for Rieke® spout can be used. Choice of 7 adaptors makes the pump good for use with most metal & plastic containers
- Pump length can be extended by over 100 mm for use on extra depth containers, by conveniently sliding the suction tube extender
- Supplied complete with rigid steel discharge spout & 1200 mm long spring reinforced non kinking discharge hose fitted with non drip spout

PL410, PL411 & PL412

MANUAL OIL SUCTION GUNS STEEL OR POLYCARBONATE BARREL



Product Code	Description	Capacity
PL410	Manual Oil Suction Gun Black Barrel	500 ml
PL411	Manual Oil Suction Gun Clear Barrel	500 ml
PL412	Manual Transfer Gun - 2 vinyl tubes	350 ml

- Rugged transfer guns designed for use with gear oils to get them both into and out of gear boxes, transfer cases and differentials
 - Deluxe lip seal provides maximum suction
 - Steel Barrel in premium powder coated finish (**PL410 & PL412**)
 - Clear polycarbonate barrel for oil condition monitoring (**PL411**)
 - Aluminium Die cast Head
 - Fully serviceable
 - Needs no priming
 - Suitable for use with non corrosive liquids
- SUCTION GUNS
- Supplied with 300 mm of clear vinyl suction tube
- TRANSFER GUN
- Supplied with 1200 mm of clear vinyl tube for each valve

PL414

MANUAL OIL LEVER GUN



Product Code	Description	Capacity
PL414	Manual Oil Lever Gun	500 ml - 10,000 psi

- Heavy Duty Oil Gun handles flowable greases & light oils without leakage
- High Quality Steel Barrel with fully machined seam for leak proof operation
- Grease Gun Follower designed for use with both Oils & Grease & works with 14 oz. (400 gm) Grease cartridge or 500 cc Bulk without the need to flip the follower
- Develops up to 10,000 psi / 690 bar
- Variable stroke feature built in for use in confined areas
- High Tolerance Aluminum Die Cast Gun Head
- Complete with a 150 mm steel extension & professional 4 jaw coupler with ball check



PL417

PREMIUM OIL SPIGOT/DISPENSER



Product Code	Description	Thread
PL417	Oil Spigot/Dispenser for Air Operated Oil Pumps	1/2" BSP Female

- Professional quality Oil Spigot in premium chrome plated finish
- Used to construct oil bars or direct with air operated oil pumps as a dispenser
- Spring loaded dispensing mechanism CNC machined for non-drip operation
- Nitrile Seals
- Handles up to 800 psi (55 bar)

PL430 - PL435

AIR OPERATED OIL PUMPS

1:1 3:1 5:1 RATIOS

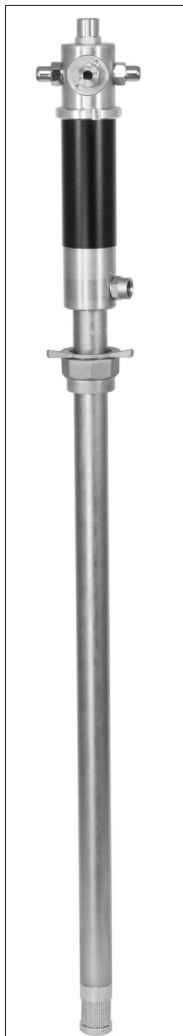

Product Code	Ratio	Description	Flow Capacity litres / min
PL430	1:1	Air Operated Oil Pump Stub Version with Bung	42
PL431	1:1	Air Operated Oil Pump complete to suit 205 litre drums	42
PL432	3:1	Air Operated Oil Pump Stub Version with Bung	14
PL433	3:1	Air Operated Oil Pump complete to suit 205 litre drums	14
PL434	5:1	Air Operated Oil Pump Stub Version with Bung	18
PL435	5:1	Air Operated Oil Pump complete to suit 205 litre drums	18

NOTE: All pumps have 1/4" BSP air inlet, 1/2" BSP Female oil outlet, 1" BSP Female Suction Tube thread

1:1 Ratio Pumps

- Transfer pump, used to quickly transfer oils from large drums to smaller containers. These have a Double Acting operation with discharge up to 40 lpm (8.80 imp. gpm).
- Ideal for use with low to medium viscosity (up to SAE 80 Oils) for transferring over short distances (5 metres)
- Air Consumption: 270 lpm (59.40 imp. gpm), max air pressure 115 psi / 8 Bar

3:1 Ratio Pumps

- Amongst the most popular general purpose air operated pumps worldwide
- Pumps are single acting with discharge up to 14 lpm (3.08 imp. gpm)
- Ideal for use with medium to high viscosity oils (up to SAE 130) for transferring over distances (up to 30 metres), mostly used with Trolley mounted kits
- Air Consumption: 230 lpm (50.60 imp. gpm), max air pressure 115 psi / 8 Bar

5:1 Ratio Pumps

- High Pressure air operated pumps for dispensing oil at 5 times the pressure as the air inlet
- Pumps are double acting with discharge up to 18 lpm (3.96 imp. gpm)
- Ideal for use with high viscosity oils (up to SAE 240) for transferring over short & long distances (up to 50 metres), mostly used with Trolley mounted kits both with & without Hose Reels, as well as with fixed systems for centralized distribution
- Air Consumption: 250 lpm (55.0 imp. gpm), max air pressure 115 psi / 8 Bar

NOTE: Wall Mounting brackets and IBC mounting kits available

LUBE EQUIPMENT

OIL ACCESSORIES

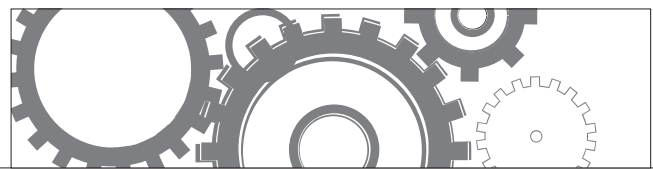

PL440

DIE CAST DRUM BUNG INTEGRATED WING NUT



Product Code	Description	Size
PL440	Die Cast Drum Bung	42 mm Inside Diameter

- Aluminum Die cast 2" Drum Bungs for use primarily with Air Operated Pumps
- Bungs can be adjusted anywhere on the suction tube & tightened using the Wing Nut
- Zinc Die cast Locking Nut inside holds the suction tube
- 42 mm Inside Diameter
- Standard equipment on all Pirtek Air Operated Oil Pumps

PL444 - PL449

SPARE PARTS FOR PIRTEK LUBE PUMPS

*REFER TO THE
INDIVIDUAL
INSTALATION,
OPERATION &
MAINTENANCE
MANUALS*

Product Code	Description
PL444	Spares to Suit PL430 / PL431 1:1 Ratio Air Motor Oil Pump Kit
PL445	Spares to Suit PL430 / PL431 1:1 Ratio Air Motor Non Return Valve Kit
PL446	Spares to Suit PL430 / PL431 1:1 Ratio Seal Kit
PL447	Spares to Suit PL430 / PL431 1:1 Ratio Piston Kit
PL448	Spares to Suit PL432 / PL433 3:1 Ratio Oil Pump Kit
PL449	Spares to Suit PL434 / PL435 5:1 Ratio Oil Pump Kit

Refer to instruction manual and/or the Pirtek Web catalogue for list of spare parts supplied.

PL450

MECHANICAL OIL METER



Product Code	Description	Measurement Range
PL450	Mechanical Oil Meter	1 - 30 litres / minute

- High pressure positive displacement meter suitable for in-line and end of line applications
- Oval gear mechanism for optimum accuracy
- High reliability Mechanical Display
- Robust Aluminum Die Cast construction with protective shroud on meter
- Accuracy $\pm 1\%$
- Repeatability $\pm 0.2\%$
- Measures Litres with Reset capability
- RECOMMENDED USE
Oils with viscosity up to 2000 cSt, Diesel, Biodiesel
- DO NOT USE WITH
Water based media, Petrol etc.
- Max pressure 1000 psi / 70 Bar
- 1/2" BSP Female
- Bottom entry, top outlet

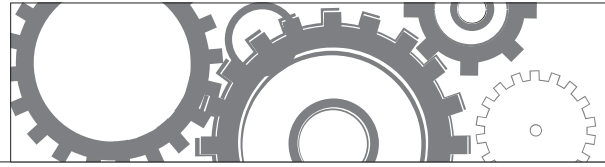

PL451

ELECTRONIC IN-LINE OIL METER



Product Code	Description	Features
PL451	Electronic Digital in-Line Meter	1-30 litres /min at up to 70 bar WP

- High pressure positive displacement meter suitable for in-line and end of line applications
- Oval gear mechanism for optimum accuracy
- Electronic Display using two 1.5V batteries
- Robust Aluminium Die Cast construction
- Measures in Litres, Quarts, Pints & Gallons
- Accuracy $\pm 0.5\%$
- Repeatability $\pm 0.3\%$
- Easy user re-calibration
- Working Pressure 70 bar Burst Pressure 140 bar
- Pressure Loss 0.7 bar
- Max. Resettable Batch Total 99,999 units
- Non-Resettable Totalisator 9,999,999 Units
- Least Count Resolution 0.001 Units
- Water Resistance IP55
- Temp. Range: -10°C to $+60^{\circ}\text{C}$
- 1/2" BSPT inlet & outlet threads
- Bottom entry, top outlet
- Batteries included

RECOMMENDED USE

- Oils with viscosity up to 5000 cSt, Diesel, Biodiesel

DO NOT USE WITH

- Water based media, Petrol etc.
- Not approved for metering commercial sales of media

PL460

OIL CONTROL GUN WITH SWIVEL c/w NON DRIP NOZZLE



Product Code	Description	Features
PL460	Oil Control Gun with Swivel / Nozzle	Up to 70 litres /min and 60 bar WP

- For use with Air Operated Oil Pumps up to 6:1 Pressure ratio
- Gun dispenses by simple press of the trigger
- Built-in safety clip can be slid over the trigger for continuous un-attended dispensing; or alternatively under the trigger to lock & prevent accidental dispensing
- Slim construction of the steel outlet spout allows the gun to be used to fill small openings
- Built-in swivel threaded at inlet for easy maneuverability
- Standard configuration includes steel outlet extension and non drip nozzle
- Temp. Range: -10°C to $+60^{\circ}\text{C}$
- 1/2" Female BSPT Swivel Inlet
- 1/2" OD Steel Extension

RECOMMENDED USE

- Oil, Gear Lube, ATF

DO NOT USE WITH

- Water based media, Petrol etc.

LUBE EQUIPMENT

OIL ACCESSORIES

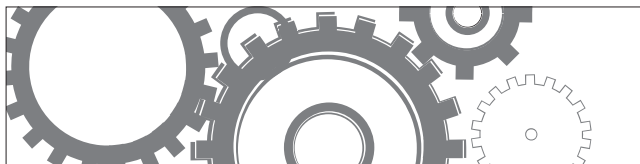

PL461

MECHANICAL OIL CONTROL GUN WITH SWIVEL c/w NON DRIP NOZZLE



Product Code	Description	Features
PL461	Mech. Oil Control Gun with Swivel / Nozzle	0.3 to 8 litres /min and 60 bar WP

- High accuracy light weight gun for controlling fluid deliveries in most demanding applications
- Oval gear mechanism for optimum accuracy
- Accuracy $\pm 1\%$
- Repeatability $\pm 0.2\%$
- Temp. Range: -10°C to $+60^{\circ}\text{C}$
- Max. Resettable Batch Total 99,999 units
- Non-Resettable Totalisator 9,999,999 Units
- Least Count Resolution 0.1 Units
- Water Resistance IP55
- High Reliability Mechanical display
- Aluminum Die cast meter body
- Gun with Impact & Weather resistant nylon construction
- Built-in safety clip can be slid over the trigger for continuous un-attended dispensing; or alternatively under the trigger to lock & prevent accidental dispensing
- Built In swivel at inlet for easy maneuverability
- Supplied complete with rigid steel tube outlet / extension and fitted with a manual non drip nozzle

Note: Optional flexible hose extension outlet available Code No. **PL467**

RECOMMENDED USE

- Oils with viscosity up to 2000 cSt, Diesel, Biodiesel

DO NOT USE WITH

- Water based media, Petrol etc.

PL462

ELECTRONIC OIL CONTROL GUN WITH SWIVEL c/w NON DRIP NOZZLE



Product Code	Description	Features
PL462	Electronic Oil Control Gun with Swivel / Nozzle	1 to 30 litres /min and 60 bar WP

- High accuracy light weight gun for controlling fluid deliveries in most demanding applications
- Oval gear mechanism for optimum accuracy
- Accuracy $\pm 0.5\%$
- Repeatability $\pm 0.3\%$
- Temp. Range: -10°C to $+60^{\circ}\text{C}$
- Max. Resettable Batch Total 99,999 units
- Non-Resettable Totalisator 9,999,999 Units
- Least Count Resolution 0.1 Units
- Water Resistance IP55
- Electronic Display using two 1.5V batteries
- Aluminum Die cast meter body
- Gun with Impact & Weather resistant nylon construction
- Built-in safety cum continuous Flow lever can be slid over the trigger for continuous unattended dispensing; or alternatively under the trigger to lock & prevent accidental dispensing
- Built In swivel at inlet for easy maneuverability
- Measures in Litres, Quarts, Pints & Gallons
- Easy user re calibration
- Supplied complete with rigid steel extension or hose extension, fitted with manual non drip nozzle
- Batteries included

RECOMMENDED USE

- Oils with viscosity up to 5000 cSt, Diesel, Biodiesel

DO NOT USE WITH

- Water based media, Petrol etc.



PL465

OIL METER SWIVEL



Product Code	Description	Threads
PL465	Oil Meter Swivel	1/2" BSPT Male - Female

- Swivel Adaptor for Oil Meters / Hose End Guns
- Large 1/2" (13 mm) inner dia. for least resistance to flow
- Steel construction with bright zinc plated finish
- Threaded 1/2" BSPT (M) x 1/2" BSPT (F)
- 103 bar (1,500 psi) rating

PL466

AUTOMATIC NON DRIP NOZZLE

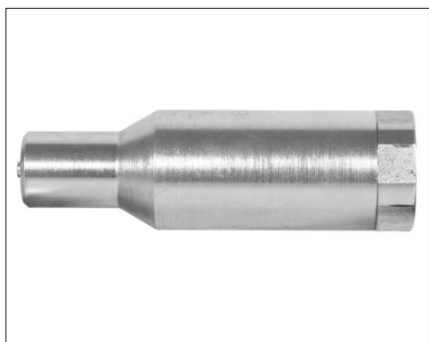

Product Code	Description	Threads
PL466	Automatic Non Drip Nozzle	1/4" BSPT Female

- Commonly used with metered oil control valves / hose end guns
- Used either with steel extensions or hoses at discharge end to cut off media supply, once filling is complete
- These have a steel construction, using NBR seals
- Automatic Non Drip Nozzle, designed with multiple check valves to achieve absolute non drip.
- The nozzle opens automatically under fluid pressure; and closes automatically with the release of pressure.
- The discharge end has a narrow section allowing the nozzle to dispense into small openings.
- Designed to minimize pressure loss
- Threaded 1/4" BSPT Female

PL467

200 MM FLEXIBLE HOSE EXTENSION



Product Code	Intended Use	Threads
PL467	200 mm Flexible Hose Extension	1/2" BSPT Male - 1/4" BSPT Male

- Flexible Oil Hose Extension for use with Oil Control Guns
- Max. Working Pressure 2,320 psi (160 bar)
- Overall Length 8" (200 mm)
- Hose Inner Dia. 1/2" (12.7 mm)
- Fittings: 1/2" BSPT (M) x 1/4" BSPT (M)

LUBE EQUIPMENT

OIL ACCESSORIES

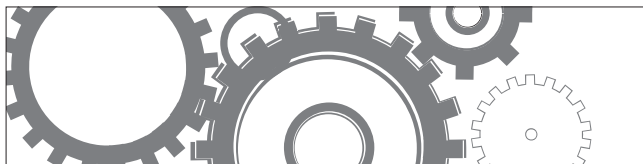

PL470

ELECTRIC OIL PUMP



Product Code	Description	Flow Capacity
PL470	Electric Oil Pump	Up to 11 litres / min and 4.5 bar

- Heavy Duty Oil pump designed specifically to transfer bulk oils, hydraulic fluid, antifreeze or antifreeze mixes
 - Non corroding Aluminium Die cast pump body
 - A high horsepower to flow ratio assures adequate power to pump viscous fluids at low temperatures
 - Self priming, positive displacement design
 - Pump has an internal bypass valve to bypass flow, if the discharge pressure exceeds the bypass valve setting
 - Built-In 2" Bung Adaptor for mounting on drums/ tanks
 - Air Cooled Motor with Thermal Protection
 - Can be used to transfer Used oil with a screen fitted onto the Suction
 - Flow: Up to 6.5 GPM (25 lpm)
 - Motor: Heavy Duty 1/2 HP 220V AC, 50 Hz.
 - Amp: 6 Amp
 - RPM: 2800
 - Construction - pump housing: Aluminum Die Cast
 - Mechanism: Gear Pump
 - Gear Material: Sintered Powder Metal
 - Internal bypass valve: Yes
 - Suction Tube: Supplied to suit 50 to 205 litre drums
 - Delivery hose: 3/4" ID x 2.4 m long
 - Bung Adaptor: 2" Threaded BSPT
 - Inlet: 1" NPT
 - Outlet: 3/4" NPT
 - Dispensing Nozzle: Ball Valve
 - Power Cable: 760mm (30")
 - Air Cooled: Yes
 - Max. Viscosity of Oil: SAE 90
 - Max. Working Pressure: 65 psi (4.5 bar)
 - Thermal Protection: Yes
- RECOMMENDED USE**
- Oils, Synthetic Oils, Antifreeze, Used Oil, Hydraulic Fluids, Cutting Oils, Oil based Herbicides, Non Flammable Oil Based Solvents, Liquid Soap etc.

PL480 & PL481

METAL OIL CANS

SUPPLIED WITH BOTH RIGID AND FLEXIBLE SPOUTS



Product Code	Intended Use	Oil Capacity
PL480	Lever Type with Brass Pump	300 ml
PL481	Lever Type with Brass Pump	500 ml

- Spout Length 125 mm (Rigid) or 150 mm (Flexible)
- All steel construction, with the body seamless drawn from tin coated sheet in premium powder coated finish
- Brass pump has 2 ball valves for large volume delivery per stroke.
- The suction valve at the bottom of pump is without spring, which prevents malfunctioning because of sticking valve due to resinous oil



PL482

PLASTIC BODY OIL CAN



Product Code	Description	Capacity
PL482	Plastic Body Oil Can	215 ml

- Unbreakable & rust resistant Plastic body Oil Cans
- Graduations marked on the bottle in both ml & oz.
- Oil discharge is through the 'squeeze action' of the Oil can bottle.
- Comes complete with telescopic steel tube with brass nut & non drip tip
- 150 mm spout length

PL484 & PL485

PLASTIC FUNNELS

ANTI-SPLASH & SPILL PROOF



Product Code	Description	Capacity	Major Diameter	Spout Length
PL484	Plastic Funnel	1.7 litre	205 mm	170 mm
PL485	Plastic Funnel with Drum Adaptor	3 litre	240 mm	245 mm

- Heavy Duty Polypropylene construction
- Designed with special contours in the funnel body for easy handling
- Anti-splash and spill proof, with rim of the funnel curved in
- Complete with Wire Mesh Screen Dust Cover & flexible spout
- PL485 with drum Bung Attachment allows the funnel to be mounted direct onto drums with 2" threaded opening
- Manufactured in translucent white to give a clear view of media

PL487, PL488 & PL489

PLASTIC MEASURES WITH SPOUTS



Product Code	Description	Capacity
PL487	Plastic Measure with Lid and Spout	1 litre
PL488	Plastic Measure with Lid and Spout	2 litre
PL489	Plastic Measure with Lid and Spout	5 litre

- Manufactured in translucent white to give a clear view of media
- Plastic Measures have a translucent High Density Polyethylene construction & are used for transferring metered quantity of fluids
- They are marked in both litres and quarts
- Come complete with a Polyethylene flexible spout with cap and polypropylene lid
- Note: Measures are not to be used as the basis of commercial transactions

LUBE/FUEL EQUIPMENT

OIL ACCESSORIES - WASTE OIL COLLECTION

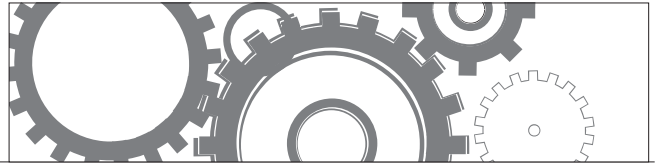

PL490

WASTE OIL DRAIN



Product Code	Description	Bowl Capacity	Collection Capacity
PL490	Waste Oil Drain Collector	10 litres	55 litres

- Tank Capacity : 68 Litre
- Bowl inner Diameter : 355 mm
- Length of draining Hose : 2 metres
- Maximum Height : 1828 mm
- Minimum Height : 1143 mm
- Recommended Draining Pressure : 0.5 bar
- Oil Drain with wheel mounted tank for gravity draining of motor, engine, gearbox & differential oils, transmission & power steering fluids etc. from all types of motor vehicles placed on auto lift or a pit
- Centrally Mounted 10 litres capacity bowl is height adjustable & can be optimally positioned allowing oil draining as well as other maintenance operations
- Durable all-steel design and reinforced castors; the unit provides a safe & affordable option for draining, transferring & evacuating used oil
- Designed for excellent mobility, easy bowl positioning & simple to use pressurized evacuation
- Comes complete with a 355mm diameter telescopic bowl that can be adjusted from 1143 mm to 1828 mm
- 68 litre tank includes a preset air regulator that allows the use of standard compressed air up to 10 bar
- Tank includes a safety valve and a reinforced dispensing hose that doubles as a sight gauge to prevent overfilling
- Not for use with fuels and corrosive media

PL500

INDUSTRIAL ROTARY FUEL TRANSFER PUMP



Product Code	Description	Flow Rate	Media
PL500	Industrial Rotary Fuel Transfer Pump	38 LPM	Most Fuels & Solvents

- FM Approved Pump for use with Class 1 & Class 11 flammable & combustible liquids
- Solid Cast Iron construction, with Sintered powdered 3 vane rotor c/w 3 Graphite vanes
- Flow 38 LPM, Self Priming
- Delivers media with a Head Lift of 6m (20 ft)
- Telescopic Suction Tube with strainer to use with 50 -205 L Drums c/w 2" bung
- Outlet : 2.4 m x 3/4" Antistatic hose, vacuum breaker, Non sparking aluminium Nozzle
- Nozzle holder
- Recommended use: Petroleum based fluids, Petrol, Diesel, Biodiesel, Ethanol blend (upto 15%), Kerosene, Naphtha, Alcohols, & other solvents compatible with the pump component
- Ideal for Barrels, Drums & tanks for quickly refueling diesel powered vehicles & Equipment
- Do Not use with water based media



PL503

HIGH FLOW 3:1 ROTARY BARREL FUEL PUMP



Product Code	Description	Flow Rate	Media
PL503	Industrial Rotary Fuel Transfer Pump	Up to 500ml / rotation	Most Fuels & Solvents

- Flow: Dispenses 205 Litres in 3 Minutes
- Die cast Aluminium construction with sintered gear driven die cast zinc rotor & vanes
- Geared Rotary barrel pump with 3 times discharge per rotation for every complete handle turn, the rotor turns 3 times
- Aluminium die cast handle with security locking latch
- Complete with 3 piece Suction tube 50 - 205 L drums c/w Bung
- Discharge hose 1.8M length
- Recommended use : Petrol, Diesel, Kerosene & Lubricating Oils up to SAE30
- **DO NOT** use with corrosive liquids, Solvents, Acids, Alkalis etc.
- **NOTE:-** Fuels Containing Ethanol & Biodiesel will cause more frequent replacement of rubber parts
- **NEVER** operate the pump near fire or source of spark. Some media may be explosive & dangerous to pump

PL510 & PL511

12V & 24V DC ELECTRIC DIESEL PUMPS

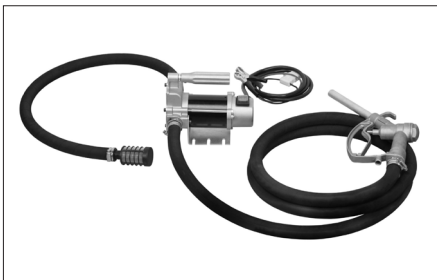

Product Code	Description	Flow Rate	Media
PL510	12VDC Electric Diesel Fuel Pump	46 litres per Minute	Diesel Fuel
PL511	24VDC Electric Diesel Fuel Pump	46 Litres per Minute	Diesel Fuel

- 12V DC or 24V DC Electric Diesel Fuel Pump
- Self Priming Vane Pump
- Portable Diesel transfer pump for every day use
- Light weight non corroding Aluminium Die cast construction
- Motor 1/4 HP
- Amp Draw from battery : 12 Amp & 8.7 Amp respectively
- Flow Rate 46 LPM
- Duty Cycle: 30min On / 30 Min OFF
- Max Working pressure 4.5 bar (65 PSI)
- Supplied with 4M hose to cut for both suction and Delivery
- Hardware included : 3 hose Barbs (3/4"), & 4 Hose clamps
- Battery cable 2m length with fuse and clamps
- Aluminium Nozzle for delivery of fluid
- Recommended use : Diesel & Kerosene
- **DO NOT** Use with fluids with a Flash Point below 38°C such as Petrol & Alcohol :- Sparking could result in explosion and fatal injury

FUEL EQUIPMENT

FUEL PUMPS

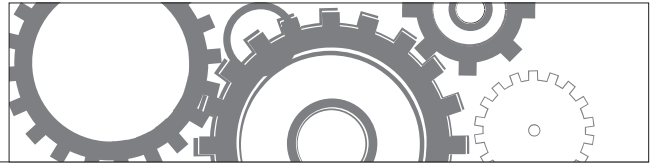

PL515

ELECTRIC FUEL AND OIL PUMP 230V AC



Product Code	Description	Flow Rate	Media
PL515	Electric Fuel & Oil Pump 230V AC	38 litres per minute	Most Fuels & Solvents

- Motor Double Insulated, safe to use with Water Emulsions
- Manufactured from chemically inert materials : POM
- Polypropylene, Stainless Steel, Nitrile Rubber, Viton & PTFE
- Working temperature range -10deg C to + 40deg C
- Flow rate : 40 LPM (measured at outlet)
- Motor 0.43 HP Centrifugal AC motor
- Internal by-pass valve : No
- Duty Cycle : Continuous Cycle
- Maximum Viscosity 114 cSt
- Built in anti-siphoning system ensures that the media does not flow out by siphon action in case of accidental damage to delivery hose or dispensing nozzle
- Built in bung adaptor to fit directly onto drum with 2" threaded opening
- Suction hose 3/4" x 1 mtr complete with stainless steel strainer
- Discharge hose 3/4" x 3 mtr long
- Dispensing nozzle 3/4" polypropylene c/w 3/4" hose barb
- Power cord : 2 mtr long
- Recommended Use : Diesel, Kerosene, Mineral & Synthetic Oils, Antifreeze, Water & Emulsions
- DO NOT Use with fluids with a flash point below 38deg C such as Petrol & Alcohol :- Sparking could result in an explosion causing fatal injury

PL517

ELECTRIC FUEL PUMP EXPLOSION PROOF 12V DC



Product Code	Description	Flow Rate	Media
PL517	Electric Fuel Pump Explosion Proof 12V DC	Up to 75 litres per minute	Most Fuels & Solvents

- Heavy Duty Industrial Grade High Flow Fuel Pump
- cUL, ATEX & IECEx listed motor
- Aluminium die cast construction, Geared pump design using sintered metal gears. Makes the pump tolerant to contaminants in fuels as well as tremendous suction and minimal noise
- Duty Cycle: 30 minutes ON / 30 minutes OFF
- Flow Rate: up to 75 LPM
- Explosion proof motor: 1/4 HP 12V DC
- Current Draw: 15 AMP
- Suction Pipe: steel
- Hose: 1" x 3.6 mtr antistatic hose
- Tank adaptor: 2" threaded spin collar for easy installation
- Inlet: 1" NPT
- Outlet: 1" NPT
- Wire mesh strainer fitted into body of pump for easy cleaning
- Dispensing nozzle: 1" manual with swivel
- Battery cable: 4.5 mtr
- Recommended use: Petrol, Diesel, E15 fuel, Kerosene, Bio-Diesel (B20)

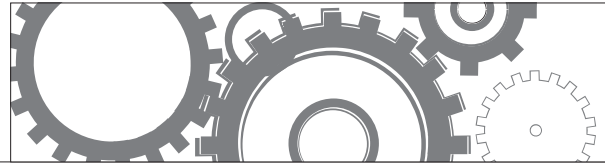

PL520 & PL521
SPARES FOR FUEL PUMP PL500

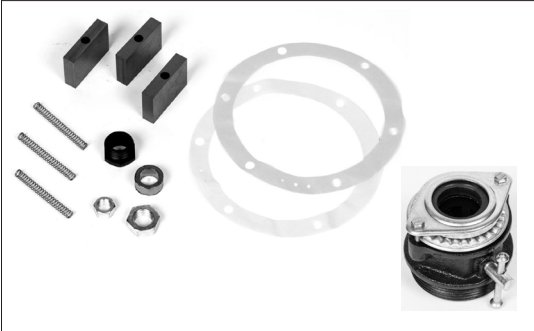

Product Code	Description	Includes	Also
PL520	Spares for Fuel Pump PL500	Gasket, Vanes, Springs	Complete Set
PL521	Spares for Fuel Pump PL500	Bung nut	c/w Flame Arrestor

Kit Includes:

- Pump head gasket
- Graphite Vanes : (3)
- Vane Springs : (3)
- Shaft nut , packing & packing nut

PL530 & PL531
MANUAL FUEL CONTROL NOZZLES

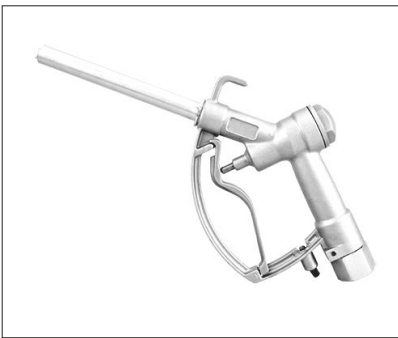

Product Code	Description	Flow Rate	Media
PL530	Manual Fuel Control Nozzle Unleaded Fuel Use	57 litres per Minute	Unleaded Fuel
PL531	Manual Fuel Control Nozzle Diesel Fuel Use	75 Litres per Minute	Diesel Fuel

- All metal Aluminium Die cast construction
- Inlet: 1" BSP Aluminium hose swivel
- Outlet discharge spout :- 3/4" diameter x 160mm long (for Petrol)
1" diameter x 160mm long (for Diesel)
- Maximum flow rate : 57 LPM (Petrol), 75 LPM (Diesel)
- Maximum pressure : 3.45 Bar (50 psi)
- For use with Electric Fuel pumps & Gravity feed
- Recommended use : All Petrols, Ethanol blends (up to 15%), Kerosene, Diesel, Biodiesel

PL540 & PL541
AUTOMATIC HIGH FLOW FUEL CONTROL NOZZLES



Product Code	Description	Flow Rate	Media
PL540	Automatic Fuel Control Nozzle Diesel Fuel Use Only	110 litres per Minute	Diesel Fuel
PL541	Automatic Fuel Control Nozzle Petrol Fuel Use Only	57 Litres per Minute	Unleaded Fuel

- Heavy-duty cast aluminium body and trigger
- Thermoplastic protective vinyl grip to protect nozzle body
- Automatic shut-off operation to prevent overfilling' and 'Includes swivel fitting
- For use with electric fuel pumps, Dual mode Manual & Automatic
- Curve spout type
- Inlet :- 1" BSP (F). Diesel (PL540)
3/4" BSP (F) Petrol (PL541)
- Outlet spout straight :- OD 30mm (1-3/16"), ID 25mm (1") diameter (for Diesel)
21mm OD (0.83") diameter (for Petrol)
- Maximum pressure :- 10 Bar
- Recommended use : All Petrols, Ethanol blends (up to 15%), Kerosene, Diesel, Biodiesel

FUEL EQUIPMENT

FUEL GUNS & METERS

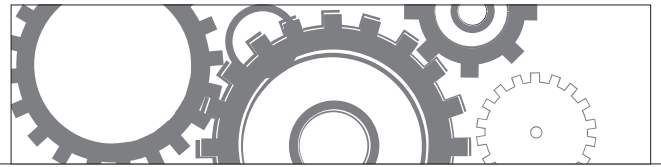

PL550

METERED FUEL CONTROL NOZZLE



Product Code	Description	Includes	Media
PL550	Metered Fuel Control Nozzle	Electronic Display	Diesel, Petrol, Biodiesel, Water

- Metered Fuel Control Nozzle
- Aluminium Die Cast Nozzle Body
- Polyamide body & sealed electronic card
- Inlet : 1" BSP (F) swivel
- Stainless Steel Adaptor included to convert Male to Female end
- Flow : 5 to 120 LPM
- Maximum Working Pressure : 10 Bar (150 psi)
- Working Temperature Range : -10°C to 50°C
- Sealed Electronics Display using Two x AAA 1.5V batteries (included)
- Water Resistance : IP55
- Maximum Resettable Batch Total : 99999 units
- Maximum Non Resettable Totalizer : 999999 units
- Least Count / Resolution : 0.001 units
- Accuracy : + / - 1%
- Repeatability : + / -0.30%
- Maximum Viscosity of media: 5.35 cst
- Recommended use: Diesel, Petrol, Bio-Diesel, Windshield Fluid, Water
- **DO NOT** use with Oils & Ethanol (incl. blends)
- **NOT** to be used for Media for RESALE

PL560

MECHANICAL NUTATING DISC FUEL METER



Product Code	Description	Includes	Media
PL560	Mechanical Nutating Disc Fuel Meter	Mechanical Display	Diesel, Petrol, Biodiesel, Oil

- Mechanical Nutating (wobble plate) Disc Fuel Meter
 - Robust Aluminium Construction
 - Nutating disc mechanism offers high tolerance to fuel contamination
 - For use with Electric Fuel pumps or Gravity flow (with a minimum gravity head of 1.2m)
 - Port size: 1" BSP (F)
 - 3 Port design which allows the meter to be fitted in line or with the inlet outlet ports at right angle
 - Register cap can be easily removed & rotated to every 90° orientation for display reading
 - Flow Rate: 15 to 75 LPM
 - Maximum Working Pressure: 3.5 Bar (50 Psi)
 - Working Temperature Range: -10°C to +65°C
 - Maximum Resettable Batch Total: 9999 Litres
 - Maximum Non Resettable Totalizer: 999999 Litres
 - Least Count Resolution: 0.10 Litres
 - Accuracy: +/- 1%
 - Repeatability: +/- 0.50%
 - Recommended use: Diesel, All Petrols, Biodiesel, Low to medium Viscosity Oils
 - **DO NOT** use with water based fluids
- Manual calibration required upon installation.



PL561

DIGITAL TURBINE METER



Product Code	Description	Features	Media
PL561	Digital Turbine Meter	Electronic Display	Diesel, Petrol, Biodiesel, Water

- Polyamide body & sealed electronic card
- Electronic Display can be rotated in 4 different positions
- Electronic Display uses two x AAA 1.5V batteries (included)
- Inlet / Outlet : 1" BSP (M) MXF
- Maximum Working Pressure : 20 Bar (300 Psi)
- Flow : 5 to 120 LPM
- Temperature Range : -10°C to +50°C
- Maximum Resettable Batch Total : 99999 units
- Maximum Non Resettable Totalizer : 999999 units
- Accuracy : + / - 1%
- Repeatability : + / - 0.30%
- Water Resistance : IP55
- Recommended use : Diesel, Petrol, Bio-Diesel, Windshield fluid, Water
- DO NOT use with Oil

PL570, PL571, PL573

FUEL FILTER 1" BSP, REPLACEMENT ELEMENT & FUEL FILTER BOWL W/DRAIN



Product Code	Description	Flow Rate	Media
PL570	Fuel Filter 1" BSPP	10 Micron Paper	Diesel & Petrol Fuels
PL571	Fuel Filter - Replacement Element	10 Micron Paper	Diesel & Petrol Fuels
PL573	Fuel Filter Bowl w/drain Suit PL570	10 Micron Paper	Diesel & Petrol Fuels

- Fuel Filter 1" BSP (F)
- High Flow Filter with 10 Micron Paper Element fitted
- Aluminium Die cast head
- Translucent Polypropylene Filter Bowl c/w Brass drain cock
- Removes Small particles of Rust, Dirt, Scale, Grit, Sand & lint at gravity flow 19 Litres / minute with only 600 mm head
- Maximum Working Pressure : 10 Bar (150 Psi)
- Recommended use : Diesel and Petrol
- DO NOT use with water based products, Ethanol blend fuels, Aviation Fuels, Race Fuels etc.
- Replacement Filter Element PL571

PL572

FUEL FILTER WRENCH



Product Code	Description	Features	Material
PL572	Fuel Filter Wrench	Fuel Filter PL570	Reinforced Nylon

- Suits Fuel Filter PL570
- Weather resistant reinforced Nylon construction
- In addition fits other maker :
Golenrod Models: 495 & 496
Baldwin Model: B10AL
National Spencer Model: NS-10
John Deere Models: TY15192 & TY15677 etc.

DISPENSING EQUIPMENT

MANUAL CHEMICAL PUMPS

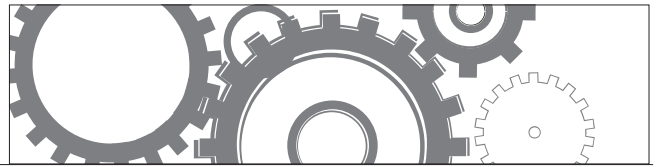

PL600

ROTORY CHEMICAL PUMP



Product Code	Description	Flow Rate	Media
PL600	Rotary Chemical Pump	5 litres per 20 turns	Antifreeze, Fuel, Ad-Blue, Acid etc

- Pump Body made from Glass filled Polypropylene with Ryton Vanes
- All Seals are Viton & all pump hardware is Stainless Steel
- Threaded Polypropylene suction tube suits 50 to 205 Litre drums
- 2 x bung adaptors included
- Strainer fitted to the suction tube stop contaminants from entering the pump
- Delivers: 5 litres per 20 turns
- Recommended use: Dispensing water based media, Antifreeze, Urea, AdBlue, DEF, Benzene
- Also: Detergents, Glycerine, Acids, Chemicals, etc.
- In addition: to use with all Light weight petroleum based products
- **DO NOT** use with Acetone, Lacquer, Mineral oils, Solvents, Turpentine, etc.

PL601

LEVER ACTION CHEMICAL PUMP



Product Code	Description	Flow Rate	Media
PL601	Lever Chemical Pump	500ml per stroke	Antifreeze, Fuel, Ad-Blue, Acid etc

- Lever Action Chemical Pump
- Wetted Components: Polyacetal, Polypropylene, PVC & Viton
- Anti siphon vent cap when loosend breaks the siphon action
- Built in 2" Bung Adaptor
- Flow: 500 ml per Stroke
- Suction tube suits 50 to 205 Litre drums
- Pump outlet fitted 2 M x 3/4" flexible corrugated discharge hose
- Design makes it extremely comfortable to pump thick oils without excessive fatigue
- Recommended use: Water based media, Detergents, Soaps, Antifreeze, windshield washer fluid
- Also: Hydraulic oils, Lubricants, Herbicides & Pesticides, Ad-Blu, Urea, DEF
- Pump should **ONLY** be used with **NON** flammable liquids

PL610

MANUAL HEAVY DUTY SIPHON PUMP



Product Code	Description	Flow Rate	Media
PL610	Siphon Pump	21 litres per minute	Antifreeze, Fuel, Ad-Blue, Acid etc

- Up/Down lever action
- Easy to use Polyethylene Pump, siphon liquids to lower levels than the height of pump
- Easy to prime and start within 6 to 7 strokes
- Suits 205 litre drums, suction tube length 1212 mm
- Flow: 21 LPM
- Flexible corrugated discharge hose length 1200 mm
- Recommended use: Water based fluids, Detergents, Waxes, Soaps, Antifreeze, mild acid
- Also Detergents, Glycerine, Acids, Chemicals, etc.
- In addition: to use with all Light weight petroleum based products
- Do NOT use with Acetone, Lacquer, Mineral oils, Solvents, Turpentine, etc.
- Pump should only be used with light weight & **NON** Flammable media
- **DO NOT** use with any media not compatible with materials used in the pump construction
- **WARNING:** Pumps must never be used with **HOT** media at temperatures above +60°C



PL670

DRUM WRENCH



Product Code	Description	Material	Bung Sizes
PL670	Drum Wrench	Cast Aluminium	2" and 3/4"

- An easy & convenient tool to open almost all types of drums
- Wrench is manufactured from cast aluminium (LM25) hardened & tempered to increase strength
- Ends of Wrench are designed to fit perfectly into most 2" & 3/4" drum plugs

PL671

DRUM FAUCET / TAP



Product Code	Description	Material	Thread Size
PL671	Drum Faucet / Tap	High Density Polyethylene	3/4" BSP

- Body : High density Polyethylene. Knob: Low density Polyethylene
- Fits into 3/4" threaded opening on 205 litre drums
- Facilitates convenient dispensing of media under gravity flow with the drum laid horizontally

PL672

ALUMINIUM DRIP PAN

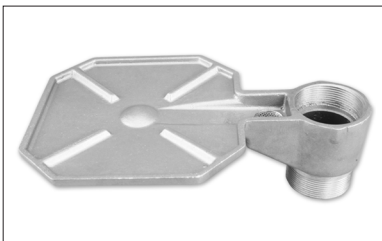

Product Code	Description	Material	Thread Size
PL672	Aluminium Drip Pan	Cast Aluminium	2" BSP

- Used as a drain for returning over flown media during dispensing
- Fits into any 2" threaded opening on a drum barrel or tank
- It additionally works as a base for holding a container during dispensing
- Keeps workplace clean & eliminates wastage, saving money each time the pump is used
- Designed with built in 2" bung adaptor & strainer for draining clean media back into the drum

PL673

DRUM BUNG CONVERTER



Product Code	Description	Material	Thread Size
PL673	Drum Bung Converter	Polypropylene Co-Polymer	2" Fine x 2" Coarse

- Converts 2" Fine threads found on most pumps / drum bungs to 2" male coarse
- Making the pumps good for use on Plastic drums with 2" coarse female threads
- Construction: Polypropylene co-polymer designed with 4 protrusions for easy tightening
- Dimensions: 82 mm diameter x 34 mm high

AIR EQUIPMENT

AIR LINE EQUIPMENT & GUNS

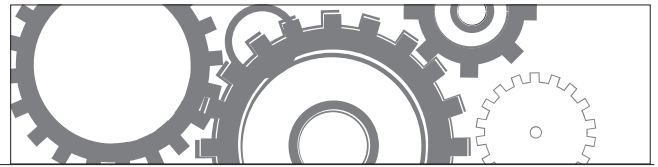

PL710, PL721 & PL725

MINIATURE 1/4" FILTER REGULATOR LUBRICATOR (2 PIECE)

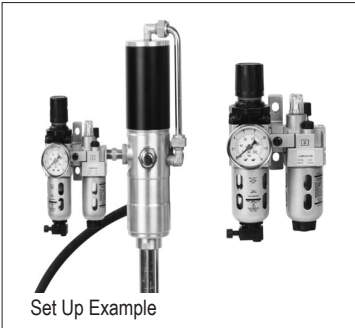

Set Up Example

Product Code	Description	Description	Sizes
PL710	Miniature 1/4" FLR	Die Cast Aluminium / Polycarbonate	1/4"
PL721	FRL Miniature Piping Adaptors	Used to connect PL710 FRL Units	1/4"
PL725	Spare Filter Element	Suit PL710 Filter	5 Micron

- Miniature 1/4" Filter Regulator Lubricator (2 piece)
- Die cast Aluminium Construction c/w Polycarbonate bowl with steel bowl guard
- Pressure Gauge & Mounting Bracket included
- Ports: 1/4" Bsp
- Flow: 500 Lpm (18 cfm)
- Maximum Pressure : 10 Bar (145 Psi)
- Pressure Adjustment Range of 0.5 - 10 Bar. (7 - 145 Psi)
- Filter Element: 40 Micron
- Press type manual drain with "night time drain"

PL730 & PL731

AIR BLOW GUNS WITH STAINLESS STEEL NOZZLES



Product Code	Description	Materials	Inlet Port
PL730	Air Blow Gun with 114 mm Nozzle	Body: Nylon Nozzle & Parts: S/Steel	1/4" BSP Fem.
PL731	Air Blow Gun with 330 mm Nozzle	Body: Nylon Nozzle & Parts: S/Steel	1/4" BSP Fem.

- Air Blow Gun with 114 mm & 330 mm nozzles
- Impact & weather resistant Nylon Body
- Stainless Steel Nozzle & parts
- Drop resistant construction
- Handle with Soft rubber grip for convenience & continuous use
- Variable speed trigger
- Ergonomic design of the gun helps eliminate the risk of Carpel Tunnel
- Connection : Brass threaded 1/4" BSP (F)
- Operating Pressure : 3.5 - 16 BAR (50 -235 Psi)
- Blowing Force at 6.8 bar = 0.35 Kgs
- Air Consumption: 15.18 CFM & 15.26 CFM @ 6.8 Bar respectiely
- Noise Level : 80 db @ 100 Psi

PL735

AIR BLOW GUN POLYACETAL BODY



Product Code	Description	Material	Thread Size
PL735	Air Blow Gun	Body: Polyacetal, Nozzle: Aluminium	1/4" BSP Fem.

- Polyacetal Body (POM)
- Non corroding Aluminium nozzle
- Variable Speed trigger ensures for full control of amount of air dispensed
- Connection : Brass threaded 1/4" BSP (F)
- Operating Pressure : 3.5 - 10 BAR (50 - 150 Psi)
- Blowing Force @ 6.8 Bar = 0.472 Kgs
- Air Consumption: 19.06 CFM @ 6.8 Bar



PL739

AIR BLOW GUN KIT C/W 6 INTERCHANGEABLE ACCESSORIES



Product Code	Description	Material	Thread Size
PL739	Air Blow Gun Kit	Body: Nylon, Accessories: Aluminium & Rubber	1/4" BSP Fem.

Includes:

- Air Blow Gun PL730
- 100mm Protective Shield
- Soft Rubber Star Tip Nozzle for use on delicate materials
- 12.7 mm Rubber Tip for blowing out lines & cavities
- 25 mm Rubber Tip for blowing out lines & cavities
- 35 mm Rubber Tip for blowing out lines & cavities
- Venturi Nozzle turbo charges output. Great for blowing out dust, drying off and washing parts fast

PL740

AIR BLOW GUN



Product Code	Description	Materials	Thread Size
PL740	Air Blow Gun	Body: Die Cast Aluminium, Nozzle: Rubber	1/4" BSP Fem.

- Metal Lever Air Blow Gun
- Manufactured from Die Cast Aluminium
- Feature revolutionary Venturi Mechanism that uses side ports to combine free ambient air with costly compressed air, creating a much higher volume of usable output
- Ergonomic design of the body & large dip coated lever reduces user fatigue & discomfort, even during extended use
- Maximum Pressure: 10 Bar (150 Psi)
- Threaded 1/4" (F) at inlet & 1/8" (F) at outlet
- 1/2" Rubber Tip
- Maximum DBA : 85

PL749

BLOW GUNS & ACCESSORIES KIT



Product Code	Description	Materials	Thread Size
PL749	Air Blow Guns & Accessories Kit	Various	1/4" BSP Fem.

- Lever air blow gun kit with interchangeable tips
- Accessories supplied in tough plastic case and includes:-
- * 2 x PL740 Metal blow guns
- * 1/2" Rubber tip
- * Standard tip
- * Standard safety tip
- * High flow safety tip
- * Safety booster tip
- * Safety tamperproof tip
- * 1" Rubber tip
- * 1.3/8" Rubber tip
- * Soft rubber star tip
- * Adjustable brass tip
- * Nylon screen 1.1/4" wide tip
- * Nozzle with 4" protective shield tip
- * Nylon tapered tube 3" long tip
- * Mini aluminium tip
- * S/S needle 1.3/4" long x 1.8mm dia. tip
- * S/S needle 2.15/32" long x 2.4mm dia. Tip
- * Steel wire brush tip for industrial cleaning & drying
- * Extended reach Aluminium tube 3" long tip
- * Extended reach Aluminium tube 6" long tip

LUBE EQUIPMENT

POWERED PUMPS

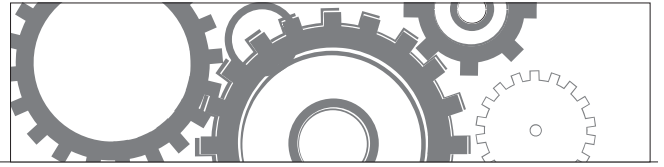

ALE-15FPH

AIR OPERATED DIAPHRAGM PUMP

POLYPROPYLENE BODY



Product Code	Description	Pump Capacity
ALALE-15FPH	1/2" Poly Diaphragm Pump	45 litres / minute

- Air operated double diaphragm pumps for use in a wide variety of industries
- A reliable, cost effective and versatile means of transferring fluids
- Suitable for the transfer of a wide variety of fluids including engine oil, gear oil, waste oil, some chemicals, caustic, antifreeze and waste water
- Polypropylene body with easily replaced Hytrel diaphragms
- All bolted construction enables easy servicing

Air Motor: Ryton®
 Port Dimensions: 1/2" BSPT Female
 Max. Liquid Temperature : 120°C
 Air Inlet (includes ball valve): 1/4" NPT (F)
 Air Exhaust: 3/8" NPT Female
 Air Supply: 20 - 100 psi (1.4 - 7 Kg/cm²)
 Discharge: 128 ml per cycle
 Max. Cycle Rate: 400 Cycles per minute
 Max. Size Solid: 1 mm
 Max. Dry Lift (Suction): 2.4 m
 Weight: 3.5 Kgs

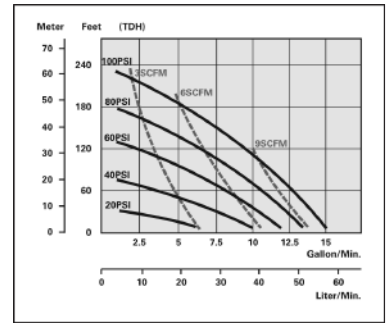

ALE-xxBAH

AIR OPERATED DIAPHRAGM PUMP

ALUMINIUM BODY



Product Code	Description	Pump Capacity
ALE-20BAH	Aluminium Diaphragm Pump 3/4" NPT	100 litres / min maximum
ALE-25BAH	Aluminium Diaphragm Pump 1" NPT	180 litres / min maximum

Air Motor: Aluminium
 Port Dimensions: 3/4" NPT Female
 Max. Liquid Temperature : 120°C
 Air Inlet: 1/4" NPT Female
 Air Exhaust: 3/4" NPT Female
 Air Supply: 20 - 100 psi (1.4 - 7 Kg/cm²)
 Discharge: 615 ml per cycle
 Max. Cycle Rate: 195 Cycles per minute
 Max. Size Solid: 2 mm
 Max. Dry Lift (Suction): 5.48 m

Air Motor: Aluminium
 Port Dimensions: 1" NPT Female
 Max. Liquid Temperature : 120°C
 Air Inlet: 3/8" NPT Female
 Air Exhaust: 3/4" NPT Female
 Air Supply: 20 - 100 psi (1.4 - 7 Kg/cm²)
 Discharge: 833 ml per cycle
 Max. Cycle Rate: 210 Cycles per minute
 Max. Size Solid: 4.8 mm
 Max. Dry Lift (Suction): 5.48 m

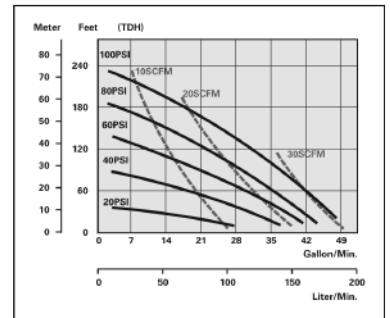
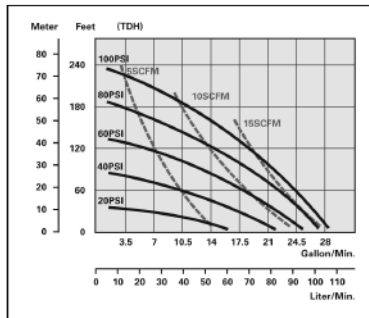

Performance Graphs based on 305 mm flooded suction, with water at ambient temperature

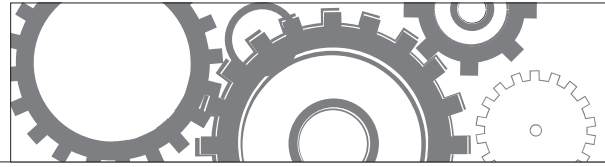

AL20066N2 LED CORDLESS WORKSHOP LIGHT



Product Code	Description	Features
AL20066N2	LED Work Light with Aircon Gas Leak Detection Capabilities	Inspection Light / Gas detection

- Gas leak detection capabilities
- 4W COB LED, 400lm on body
- 3W SMD LED, 100lm on top
- 80 CRI to illuminate true colours
- 6500K
- 3.7V 2200mAh Li-ion battery
- 3 hour main light run time
- 10 hour top light run time
- 28 hour top UV light run time
- 3.5 hour charge time
- 180° adjustable handle
- 3 strong magnets
- 2 foldaway hanging hooks
- IP54 foreign objects / moisture intrusion rating

DISPENSING EQUIPMENT

P-SERIES HOSE REELS

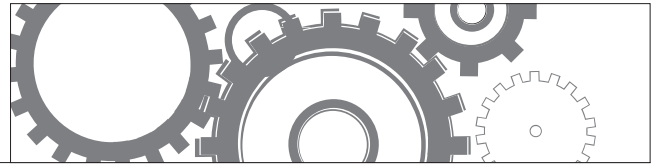

HRPG15-R2-04-04BTF

POLYPROPYLENE GREASE HOSE REEL



Product Code	Intended Use	Hose	Inlet	Outlet	Length	W.P	W.T
HRPG15-R2-04-04BTF	Grease	PIRTEK FRAS R2	1/4" NPT	1/4" BSPF Swivel	15MT	5000 psi	-30C - +90C

- Compact and lightweight
- Tough construction
- Impact and corrosion resistant
- All positive latching system
- Easy Service and mounting
- Anti-static and flame retardant
- Self Retracting
- General workshop and mobile equipment application

HRPO15-R1-08-08BTF

POLYPROPYLENE OIL HOSE REEL



Product Code	Intended Use	Hose	Inlet	Outlet	Length	W.P	W.T
HRPO15-R1-08-08BTF	Oil	PIRTEK FRAS R1	1/2" BSPF	1/2" BSPF Swivel	15MT	1200 psi	-30C - +90C

- Compact and lightweight
- Tough construction
- Impact and corrosion resistant
- All positive latching system
- Easy Service and mounting
- Anti-static and flame retardant
- Self Retracting
- General workshop and mobile equipment application

HRPW15-MP-08-08BTF

POLYPROPYLENE AIR & WATER HOSE REEL



Product Code	Intended Use	Hose	Inlet	Outlet	Length	W.P	W.T
HRPW15-MP-08-08BTF	Air & Water	PIRTEK PVC	1/2" BSPF	1/2" BSPM	15MT	250 psi	-5C - +65C

- Compact and lightweight
- Tough construction
- Impact and corrosion resistant
- All positive latching system
- Easy Service and mounting
- Self Retracting
- General workshop and mobile equipment application
- Compressed Air
- **Modified Pirtek PVC Hose**

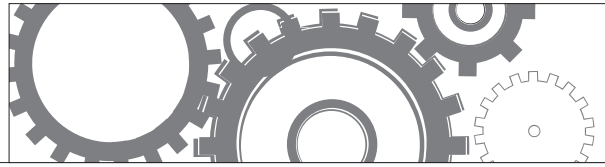

HRSG15-R2-04-04BTF

STEEL GREASE HOSE REEL



Product Code	Intended Use	Hose	Inlet	Outlet	Length	W.P	W.T
HRSG15-R2-04-04BTF	Grease	PIRTEK FRAS R2	1/4" BSPPM	1/4" BSPPF Swivel	15MT	8700 psi	-30C - 130C

- Durable and compact
- High quality solid construction
- Wall, floor, ceiling or vehicle mounting
- Designed for Heavy Duty
- Self retracting
- Easy to operate and maintain
- External swivel male fitting

HRSO15-R1-08-08BTF

STEEL OIL HOSE REEL



Product Code	Intended Use	Hose	Inlet	Outlet	Length	W.P	W.T
HRSO15-R1-08-08BTF	Oil	PIRTEK FRAS R1	1/2" BSPPM	1/2" BSPF Swivel	15MT	2320 psi	-30C - 130C

- Durable and compact
- High quality solid construction
- Wall, floor, ceiling or vehicle mounting
- Designed for Heavy Duty
- Self retracting
- Easy to operate and maintain
- External swivel male fitting

HRSW15-R1-08-08BTF

ENCLOSED STEEL AIR & WATER HOSE REEL



Product Code	Intended Use	Hose	Inlet	Outlet	Length	W.P	W.T
HRSW15-R1-08-08BTF	Air & Water	PIRTEK FRAS R1	1/2" BSPF	1/2" BSPF Swivel	15MT	2320 psi	-30C - 130C

- Durable and compact
- High quality solid construction
- Wall, floor, ceiling or vehicle mounting
- Designed for Heavy Duty
- Self retracting
- Easy to operate and maintain
- External swivel male fitting

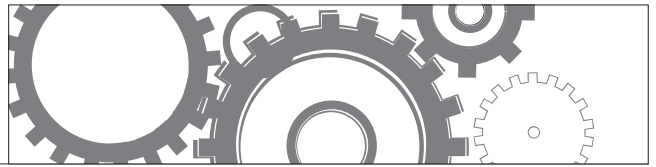

P-Series Hose reel Spares/Service Parts:

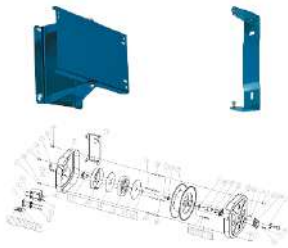

REPLACEMENT PARTS	
Product Code	Description
IPPAW-013060	12mm Modified PVC - Blue with Yellow Stripe Hose - 60mtrs coil
HRP-SPRING-KIT	Spring and drum assembly for P Series reels
HRP-MOUNT-BK	Spare Mounting Brackets (Pair)
HRP-MN-BK	Bracket adaptor plate – To suit Macnaught R2, R3 & AK Reels.
HRP-SERVICETOOL	Service tool for P-Series Reel
HRP-SWF-04	Swivel Joint, 90deg, 1/4", 600 bar pressure (Grease)
HRP-A/W O-04	Swivel Joint, 90deg, 1/4", (Air/Water and Oil)

S-Series Hose reel Spares/Service Parts:

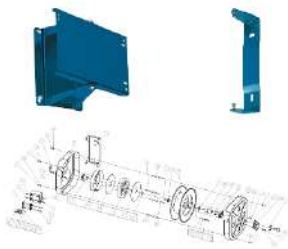

REPLACEMENT PARTS	
Product Code	Description
HRS-BRACKET-G/O	Hose reel bracket (steel) - Grease / Oil
HRS-BRACKET-A/W	Hose reel bracket (steel) – Air / Water
HRS-SPRINGKIT-G/O	Spring kit for hose reel 15 mt – Grease / Oil
HRS-SPRINGKIT-A/W	Spring kit lowered hub for hose reel 15 – Air / Water
HRS-SPRINGPAWLKIT	Spring pawl kit inox for hose reel
HRS-BRA/SHAFTKIT	Bracket and shaft kit – Grease/Oil hose reels
HRS-SWF-0808-600	Swivel fitting 1/2" - 600 bar



This page is intentionally left blank



This page is part of a complete catalogue containing technical and safety data.
All data must be reviewed when selecting a product.
Pirtek reserve the right to change technical specifications without notice.

This page is intentionally left blank



LANOLIN PROTECT

LANOLIN LUBRICANT



Lanolin is a totally natural wax (wool grease). Pirtek's formulation enhances this non-toxic product providing long term protection on any surface against rust, acids, alkaline and salts.

Our Lanolin Lubricant range is available in both liquid sprayable and grease form.

Pirtek Protect Lanolin Lubricant Aerosol is a general purpose sprayable form of Protect grease which dries to a fine grease "wet" film offering the same characteristics as the grease on exterior surfaces for multi-purpose use as a lubricant for moving parts, protectant against corrosion, fluid displacement and a penetrant to free up rusted parts.

Pirtek Protect Lanolin Lubricant Liquid is a heavy duty, higher lanolin content, thick sprayable form of Protect grease which dries to a heavy duty grease "wet" lubricant for moving parts, protectant against corrosion, fluid displacement and a penetrant to free up rusted parts.

Features & Benefits:

- Long-lasting lubrication for all moving parts
- Protects equipment from atmospheric acid and salt corrosion
- Displaces moisture from surfaces, protecting them from corrosion
- Penetrates metal surfaces preventing wear and providing extended protection
- Penetrates seized parts for easing releasing
- High thermal and mechanical stability. Resists breakdown in high temperatures and temperature variations
- Non-conductive /Di electric up to 70kV, **do not apply to live electrical equipment**. Non Flammable
- Protects electrical applications and appliances from moisture and corrosion
- Resists breakdown in high temperatures and temperature variations
- Resistant to wash off
- Food safe, suitable for use around food preparation and processing machinery
- Environmentally friendly and Biodegradable

Common Uses:

- Lubricates moving parts, chains and blocks
- Lubricates O-rings, linkages, pivot pins and bushes
- Penetrates rusted surfaces to free nuts and tools
- Protects exterior surfaces from surface rust
- Lubricates and protects chains and boat trailer springs
- Protects metal fastenings and fittings from corrosion
- Ideal for marine applications and outboard motors to protect against salt spray

Pirtek Protect Lanolin Lubricant Grease is a thick, tacky grease with high load capabilities that will not wash out under most conditions, from underwater to general applications. Lanolin lubricant grease is an all-round product that provides excellent results as a lubricant, anti-corrosive and thread anti-seize.

Features & Benefits:

- Excellent anti-seize compound with exceptional lubricity in order to prevent wear-reducing galling, fretting, seizing and corrosion
- Protection between all metals from galvanic corrosion
- Acid and salt resistant
- Assists in lubricating for ease of disassembly of parts
- Displaces moisture, lubricates all surfaces and will not wash off
- High thermal and mechanical stability. Resists breakdown in high temperatures and temperature variations
- Non-conductive /Di electric up to 70kV, **do not apply to live electrical equipment**. Non Flammable
- Food safe, suitable for use around food preparation and processing machinery
- Environmentally friendly and Biodegradable

Common Uses:

- Lanolin grease acts as anti-seize for threaded rod, shackles, nuts and bolts
- Stops galling of Stainless Steel and Aluminium threads
- Stops electrolysis due to dissimilar metal contact
- Lubricates rubber o-rings, gaskets, seals, linkages, pivot pins and bushes. ***Not to be used as a high speed bearing lubricant.**
- Lubricates and protects chains and boat trailer springs
- Protects metal fastenings, fittings, wire rope, propellers and skegs from corrosion
- Seals timber joints, bridge bearers and timber ends

Product Code	Description
PIR300C	300GM AEROSOL WITH UNI SMART STRAW CORROSION PROTECTOR
PIR750ML	750ML TRIGGER PACK CORROSION PROTECTOR
PIR5L	5LTR JERRY LIQUID LANOLIN LUBRICANT
PIR20L	20LTR DRUM WITH TAP LIQUID LANOLIN LUBRICANT
PIR200L	200LTR DRUM WITH AERATOR LIQUID LANOLIN LUBRICANT
PIRG165ML	165ML TOTTLE BOTTLE GREASE LANOLIN LUBRICANT
PIRG1LP	1LTR PAIL GREASE LANOLIN LUBRICANT
PIRG4LP	4LTR PAIL GREASE LANOLIN LUBRICANT



This page is part of a complete catalogue containing technical and safety data.
All data must be reviewed when selecting a product.
Pirtek reserve the right to change technical specifications without notice.

LANOLIN PROTECT

CORROSION PROTECTOR



Pirtek Protect Corrosion Protector is a high-performance lanolin film that forms a low tack "dry" coating that resists build up while forming a moisture tight seal around substrates that will resist corrosion.

Corrosion Protector is highly robust when dry and will not flake or chip and will retain its elasticity.

Features & Benefits:

- The ultimate in lanolin barrier film coating for exterior and interior corrosion protection.
- Quick to dry and forms a low tack, moisture tight seal that resists acids, alkali, fertilizers, highly corrosive environments, moisture ingress and salt corrosion.
- Protects metals and all alloy surfaces.
- High wash-out water resistance.
- Environmentally safe, biodegradable, eco-friendly and suitable for applications around waterways and sensitive environments.
- Dielectric tested to 40kV for electrical applications.
- Non toxic, suitable for use around food preparation areas.
- Aerosol can with handy flip-up uni smart straw for wide fan coverage or direct spray.

Common Uses:

- Protecting exterior surfaces, metal fasteners and fittings from rust during storage.
- Penetrates rusted surfaces to free up nuts and tools.
- Moisture proofs and protects electrical components, switchgears and circuit boards.
- Ideal for marine applications to protect from salt spray.
- Anti-spatter protection when welding
- Protects under-bodies of 4WD off-road vehicles, along with protect trucks, trailers, bikes and agricultural vehicles including boom sprays.

Product Code	Description
PIRCP300C	300GM AEROSOL WITH UNI SMART STRAW CORROSION PROTECTOR
PIRCP750ML	750ML TRIGGER PACK CORROSION PROTECTOR
PIRCP5L	5LTR JERRY CAN CORROSION PROTECTOR

PROTECT

HIGH STRENGTH CITRUS DEGREASER



Pirtek Protect Citrus degreaser is a powerful, fast acting natural degreaser derived from citrus ingredients with low acidity and pH neutral. Ideal for the removal of glues, fats, grease, bitumen, oils, waxes and carbon deposits. Citrus degreaser provides an effective cleaning solution which can be diluted providing superior cleaning of Stainless Steel and Aluminium without the environmental or personal hazards associated with traditional toxic chemicals.

Features & Benefits:

- Non hazardous with low toxicity and odour, suitable for indoor use.
- Derived from natural citrus ingredients which is pH neutral and low acidity.
- Water soluble, suitable for different dilutions and cleaning applications.
- Food safe for use around food preparation and process areas.
- Fresh citrus aroma.
- Aerosol can with handy flip-up uni smart straw for wide fan coverage or direct spray.

Common Uses:

- Cleaning and degreasing of heavy machinery and plant.
- Breaking down of hydrocarbons, bitumen, shipping waxes, adhesives and carbon build up.
- Industrial cleaning of surfaces and parts cleaning washes.
- Workshop and floor cleaner in preparation for painting and concrete sealing.
- Cleans air conditioning filament filters and recyclable filters.
- Cleaning and degreasing of alloys and Stainless Steels.
- De-carbonizing electrical motors and generators.
- Removal of permanent markers, inks and fresh graffiti.
- Removal of Pirtek Lanolin Products

Product Code	Description
PIRDG300C	300GM AEROSOL WITH UNI SMART STRAW CITRUS DEGREASER
PIRDG750ML	750ML TRIGGER PACK CITRUS DEGREASER
PIRDG5L	5LTR JERRY CAN CITRUS DEGREASER



This page is part of a complete catalogue containing technical and safety data. All data must be reviewed when selecting a product. Pirtek reserve the right to change technical specifications without notice.

LANOLIN PROTECT

POINTS TO NOTE



SAFETY

- Liquid lanolin products contain specifically blended solvents that require a short time to evaporate. It is essential that the products are not applied to electrical equipment while it is live
- Lanolin products are derived from natural wax (wool grease) and are biodegradable, non toxic, and provide a safe, superior alternative to traditional petrochemical based dewatering and lubricating fluids
- Lanolin products provide high load bearing capabilities on bearings, but are not suited to use in high speed bearings
- Do not spray liquid lanolin products near fire, flame or sparks
- Lanolin products will not wash off. If surfaces coated with lanolin are to be painted, clean surfaces with white spirits, or steam clean above 65°C



EMULSION COMPATIBILITY AND LIMITATIONS (UNDERGROUND MINING)

Pirtek Protect Lanolin lubricant and anti-seize greases offer long term protection, even in the harshest conditions. They protect, lubricate, penetrate and displace.

In the harsh environment that is underground mining using longwall equipment, machinery in the longwall is subject to mine waters and emulsions. It is important to lubricate moving parts and O-rings in the machinery to ensure that the equipment is kept running smoothly and to prolong the life of the machinery.

Pirtek Protect lanolin lubricant and anti-seize grease do just that!

Independent tests have been performed for both the lanolin lubricant and the anti-seize grease. Both products were each added with longwall emulsions at a set concentrate, based on the upper limit that might be reached in field application. Both products passed an O-ring swell test and thermal stability test.

- The O-ring swell test consisted of an O-ring immersed in the lanolin lubricant mixed with a longwall emulsion, and an O-ring immersed in the anti-seize grease mixed with a long wall emulsion. The O-rings were left in the mix for 56 days at 70°C. At the end of the test date, both O-rings were found to have no significant difference in swell.
- The thermal stability test was performed on both the Protect Lanolin lubricant and anti-seize grease, to test the oil separation when these products were added to the longwall emulsion.
- The stability tests were conducted for 168 hours at 70°C. At the end of the test period, there was no oil separation in either product.
- Excessive application of Lanolin grease to fittings and threads in a hydraulic system has been reported to cause precipitation of the grease in low-flow areas such as pilot systems. This can lead to a collection of microscopic debris that may cause problems with valve operation

As a result of the this last point, the Protect lanolin product should not be allowed to come in contact with longwall emulsion hydraulic fluid. Its use should be restricted to lubrication of mechanical and electrical components external to the emulsion

FLASH POINT

Flash Point Approval has been granted to the range of Lanolin Products in accordance with Australian Standards AS2106.2:1999, using the Pensky-Martens apparatus.

Flash Point approval testing of the Lanolin Products was conducted and the approval has been granted by the Department of Mineral Resources Mine Safety Laboratory of New South Wales to Australian Standards AS2106.2:1999 in a controlled laboratory environment. The Department of Mineral Resources has also assessed the Material Safety Data Sheets (MSDS) Industrial Grade, approval has also been granted as all MSDS are compiled to the criteria of Worksafe Australia guidelines.

Flash Point testing has been undertaken to ensure that its products are safe to use in the mining industry for both Open Cut and Underground operations.



LANOLIN PROTECT

RECOMMENDED APPLICATIONS



OVERVIEW

Aerosols :

- Electrical connectors
- Lubricant for drilling, cutting, machining and pressing
- Welding anti spatter
- Component preservation
- Vehicle rust protection
- Lubrication of light chains
- Air tool lubrication
- Locks and hinges
- Rejuvenates plastics, vinyls, aluminium & powder coating
- Reduce oxidation during shipping

Sprayable Liquids:

- Harsh & corrosive environments
- Heavy chain & wire rope (non sling & non webbing)
- High speed and load bearing chains
- Battery terminals & connectors e.g. electrical fork trucks
- Assembly lube for rubber hoses & multi pin plugs
- Preservation & protect motors & bearings
- Outside storage protection

Greases:

- Food grade certified
- Non conductive to 70KV
- Rubber grease, non perishing, excellent belt grip
- Welding nozzle dip
- Drilling & cutting aid
- All purpose lubricant
- Anti-seize for nuts & bolts
- Metal to metal soft seal gasket
- Stop galling of st. steel & alumin.
- Stops electrolysis of dissimilar metals

Release Agents:

- Concrete form work
- Water resistant
- Self healing
- Stops swelling of timber end grain
- Less cleanup after stripping
- Extends formwork life
- No damage to the environment

MINING

Pirtek Protect products are ideal in the mining environment because they provide what is effectively a hermetic seal or encapsulation of the targeted equipment. This protective film offers:

- environmental friendliness
- safety for workers
- non-toxicity
- superior dielectric performance
- long term pro-active protection
- Reduced acid etching
- great lubrication and anti-seize properties
- reduced hydrolysis
- reduced dismantling time and improved safety
- better opportunities for maintenance and therefore reduced downtime
- easy clean up

Use it on

- Roof Bolters - Drive chains, fittings, linkages and guides
- Rib Bolters - Drive gears, fittings, linkages
- Miner- Drive chains, chassis and protective covers, linkages, fittings, actuator pins, mounting bolts, electrical equipment and connections
- Shuttle Car- Universals and drive chains, linkages, fittings, cable level wind system, chassis, electrical equipment and connections, haulage chains and flight bars, mounting bolts, actuator pins and sprockets
- Mobile boot end- Drive chains, track adjustment bolts, guides, fittings, linkages, hinges and electrical equipment, chassis and protective covers
- Pumps and fan systems- linkages, protective covers, pump/fan housing, electrical equipment and fittings
- Conveyor Belts- Chains, shackles, turn buckles, electrical equipment, loop take up system, wire cables fittings, rollers, hanging brackets, pins, drive units, nuts/bolts, belt stands and rails

Long Wall Mining Operation

- Chock Supports- Linkages and electrical equipment
- Actuator pins, actuators, relay bars and guides
- Alternating Face Conveyor- Electrical equipment (motors etc), dog bone bolts, chain drives, sprockets, linkages, guides, threads (except hydraulic), main gate and tail gate drive units
- Stage Loader and Crusher Unit- Linkages, electrical equipment, guides, threads (except hydraulic) and bolts
- Pump Station- Pumps (except internal), electrical motors, filters, threads (except hydraulic) and bolts
- Conveyor Belts- Chains, shackles, turn buckles, loop take up system, electrical equipment, fittings (except hydraulic), wire cable, rollers, hanging brackets, pins, drive units, belt stands and rails

Washing or Screening Plant

- Conveyor belts- Electrical equipment, chains, shackles, wire cables, loop take up system, fittings, hanging brackets, pins, belt stands and rails
- Electrical Equipment- Motors, fittings, connections, lighting, camera surveillance systems, transformers, circuit breakers and distribution panels
- Screening & washing system- Electrical equipment, drive units, chains, wire rope, pins, fittings, slides, nuts & bolts

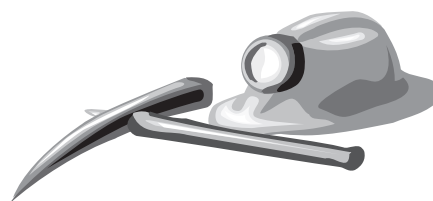

LANOLIN PROTECT

RECOMMENDED APPLICATIONS



METAL PRESERVATION

The metal preservation properties of Lanolin date back to ancient times. With modern refinement methods, Pirtek Protect offers you a product that can assist in so many ways. Machined, fabricated or ground components can be hermetically sealed against oxidization.

Benefits:

- Hermetic component preservation
- Remains pro-active
- Resists acid etching
- Great anti-seize properties
- Non-toxic lanolin film
- Easy clean up

Technical:

- Remove all oxidation or existing scale (e.g. wire brush)
- All surfaces must be dry and clean prior to coating
- Due to its pro-active properties, Pirtek Protect's protective coating will remain operative until removed
- A thin film of Pirtek Protect should be applied to all metal surfaces prior to storage. Lambswool pads may also be used to apply spray to components
- Pirtek Protect Products will preserve all joints and fittings for ease of servicing
- Clean off with steam cleaner or hot soapy water wash above 60°C



WELDING

Pirtek Protect can save you many hours of lost production time by taking away those annoying and costly problems of Spatter!!! Also helps preservation of weld seams and plating.

Benefits:

- Reduction of embrittlement
- Base metal protection
- Component anti-spatter release agent
- Anti-spatter agent for fabrication workbenches
- Spatter release agent for welding head
- Reduces hydrolysis
- Easy to remove (Hot water wash above 60°C)

Technical:

Pirtek Protect is recommended for all welding situations

- For MIG shields, dip the heated end of the hand-piece in Protect to prevent spatter adhesion. Repeat as necessary
- All Pirtek Protect should be left for 30 seconds to allow the hydrocarbon solvent to evaporate prior to welding
- Pirtek Protect should only be applied while welds are still hot (but only if weld surface temperature is $\leq 195^{\circ}\text{C}$)
- For best results the ideal application temperature is above 65°C
- Pirtek Protect can penetrate up to 10 microns in mild steel at approximately 65°C.



LANOLIN PROTECT

RECOMMENDED APPLICATIONS



MARINE COATING

Benefits

Hull protection:

Pirtek Protect is not and has no anti-foul qualities, but will reduce water drag factors

An ideal marine coating because of its proven ability to resist acid etching, i.e. barnacles. Subsequent re-application requires no special hull treatment such as sanding/grinding etc. Slipway or hardstand time is reduced due to the saving in preparation and spray application time

Virtually eliminates electrolysis – a little spray will stop this expensive killer

Drastically reduces bacterial attachments, thereby saving our waterways from the toxic cocktails caused by some traditional anti-fouls

Resistant to acid etching

Base metal penetration

Pro-active ability

Reduces hydrolysis

Also good for:

Outboard legs Sail Drives Bow Thrusters

Stern Drives Log Spigots Intake Pick-up Grates

Propellers

Buoys



Preparation

All equipment which has been in sea water, should first be washed down with liquid chlorine (3:1).

All boat hulls must be washed down with liquid chlorine (3:1) to kill any microscopic spore.

Fibreglass hulls: For new or previously untreated hulls a Gelcote sealer should be applied if one has not been applied previously, prior to applying Pirtek Protect. The surface must be CLEAN and DRY. Pirtek Protect should not affect the Gelcote sealer used on fibreglass hulls and there have been no reported instances where Pirtek Protect has reacted with a Gelcote sealer coating. If you are unsure about applying Pirtek Protect it is recommended that an inconspicuous section be coated to test for reactivity. If reaction occurs please do not apply Pirtek Protect.

Aluminium hulls: The surface must be CLEAN and DRY. If heavy oxidation exists, remove with aluminium cleaner, and then apply Pirtek Protect.

Previously anti-fouled hulls: Remove marine growth and loose anti-foul particles thoroughly. Surface must be CLEAN and DRY before application of our Pirtek Protect

Propellers: Clean propeller or fitting back to base metal and wash with a liquid pool chlorine at 3:1 ratio to kill any microscopic spore. (very important)

Application

Pirtek Protect Coating can be applied by:

(a) Sprays (including airless)

(b) Roller or brush

Generally 1 or 2 coats are sufficient.

Always allow evaporation time between coats and before launching. Remember Protect always remains tacky until submerged

Propellers: It is preferable to heat the metal to between 65°C to 100°C. Liberally apply Pirtek Protect Grease directly onto the hot components and rub in where practical.

Re-application

Clean off with steam cleaner or hot pressure wash. Surface may be cleaned by using Surface Prep or by hand scrubbing with hot water above 60°C.

When CLEAN and DRY, re-apply as per instructions

Maintenance

All moored hulls MUST be visually inspected, and the hull wiped down every 4– 6 weeks if required.

LANOLIN PROTECT

RECOMMENDED APPLICATIONS



AROUND THE HOME

Pirtek Protect products are ideal in the mining environment because they provide what is effectively a hermetic seal or encapsulation of the targeted equipment. This protective film offers:

- Stop squeaks from hinges on gates, doors and children's toys
- Having trouble again with that key in a padlock or door one, quick squirt protects and lubricates for long periods
- Lubricate sliding doors to restore smooth action
- Oil the bike chain and coat the bike preventing rust, Pirtek Protect works as well as a polish without the elbow grease
- Rejuvenate those dried out seals on pool pumps and filters
- Lubricate tracks for garage doors ensuring trouble free operation
- Protect your valuable tools from rust and corrosion
- Release those rusted up nuts and bolts in seconds

Antennas / aerials

Due to the composition of dissimilar metals and high thermal cycling rates, antennas / aerials can benefit greatly from an application of Pirtek Protect, especially in severe corrosive environments.

Benefits

- Penetrates joints
- Penetrates base metals
- Reduces electrolysis
- No seizing of fittings
- The oxidization process is retarded

Technical

- Remove all flaking and oxidation with a wire brush.
- Apply Pirtek Protect to the antenna installation.
- Before application all components must be dry and should be carried out on a warm to hot day for best results.
- Pirtek Protect can be used as an anti-seize during installation on all bolts and nuts to protect and extend the life of your antenna.
- Non-conductive to 70KV but will not impede electrical contacts

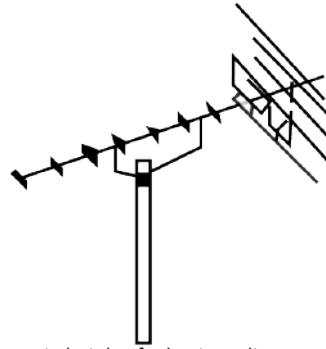

Compatible with IAA471-

TST1210

THREAD SEALING TAPE



Product Code	Description	Dimensions
TST1210	PTFE thread sealing tape - Pack of 10 rolls	12 mm Wide x 10 mtr long

- White in colour
- Compatible with hydraulic fluids, air, water and most chemicals
- Temperature range -100°C to +250°C
- Pressure rating up to 2,500 psi for higher pressures use IAS57 (rated up to 10,000 psi)

PROTECT

INDUSTRIAL ASSEMBLY PRODUCTS

REFER PIRTEK FOR MSDS SHEETS



Threadlockers :

Product Codes:

IAT43 in 10 ml and 50 ml bottles

Medium Strength Blue IAT43 Nut Lock

Description

Protect IAT43 is an anaerobic formulation designed to be used on parts in an "As Received" condition, such as those with protective films (oils) etc.

Applications

Designed for direct application onto as received parts where a light oily film exists or where surrounding parts contamination is a problem in maintenance

Useful Hint

Where possible, remove thick deposits of grease or dirt, however IAT43 will penetrate the film once it has been tightened

Properties

Use as a conventional medium strength Locker on cleaned parts with strengths up to 12N/mm² or as a convenient all purpose locker on oily parts with 8-10/mm² typical strength depending on oil type and film

Procedure for Application

Product is normally hand applied from the bottle. Full cure time 24 hours

Compatible Accelerators / Primers

Compatible with IAA471-200

Technical Features

Resin.....	Mod Methacrylate
Colour.....	Blue Thixotropic
Cure Speed.....	<15 mins @ 20°C
Viscosity.....	2500-5000
Thixotropic Gap Fill.....	.0.1mm
Flash Point.....	>85°C
Life.....	12 months @ 20°C
Specific Gravity.....	1.04
Max. Operating Temp.	-53°C to + 150°C



Threadlockers:

Product Codes:

IAT77 in 10 ml and 50 ml bottles

High Strength Red IAT77 Stud Lock

Description

IAT77 is an anaerobic locking compound in the form of a viscous paste and it is used to give high strength locking action

Applications

Mostly for fasteners of 25 mm (1" size) and above. Examples include

- Studs on Pressure Vessels
- Studs on Locomotive Units
- Hydraulic Studs on Presses
- Rock Crusher Studs
- Crawler Track Studs

Useful Hint

To speed cure or to help cure in cold conditions, use IAA471 Activator on parts

Properties

High Torque: 23.7 N-m (210 ins. lbs)

Breakloose / Prevailing Torque: 34 N-m on rotation through 180 degrees

Procedure for Application

Product is normally hand applied from the bottle. Ensure parts are clean, dry and free from oil and grease

Compatible Accelerators / Primers

IAA471 Activator can be used, but up to 30% strength reduction may be incurred

Technical Features

Resin:	Dimethacrylate
Colour:	Red
Fixture Speed with Activator:	<10 mins/6 hours
Cure Speed without Activator:1 hour/24 hours
Viscosity:	6500 cps
Gap Fill:	0.010"
Flash Point:	>85°C
Shelf Life:	12 months @ 20°C
Specific Gravity:	1.10
Max. Operating Temp.	-50°C to +150°C



Surface Preparation:

Product Code:

IAA471-200 in 200 ml Aerosol

Structural Activator for Anaerobics

Description

IAA471 Aerosol assists in speeding up the cure time of all anaerobic fluids and pastes and extends the cure through volume (especially suited to Pirtek Protect IAT43 and IAT77 threadlockers).

Applications

Use IAA471 when materials are inactive (plastics or passivated metals) or where temperature is under 15°C.

Physical Properties

Standard Grade Solvent:.....	Heptane Based
Evaporation:.....	60 seconds
Flammability:.....	Flammable
<i>Technical Features</i>	
Odour	Characteristic Odour
Viscosity	Non-Viscous
Flash Point	17°C
Boiling Point	56-57°C
Flash Point	-17 °C
Solubility in Water	Slightly Soluble



Consult Pirtek for MSDS Sheets for all Industrial Assembly Products

PROTECT

INDUSTRIAL ASSEMBLY PRODUCTS

REFER PIRTEK FOR MSDS SHEETS



Sealing & Gasketing :

Product Codes:
IAS69 in 50 ml bottle

High Strength Hydraulic Sealant - Brown

Description
 IAS69 Hydraulic Seal is an anaerobic liquid which cures to form a tough, high pressure seal on all types of threaded couplings used on low, medium and high pressure lines

Applications
 IAS69 is used for all types of hydraulic connections, sealing against typical pressure line ratings. Use Hydraulic Seal to fit valves, threaded couplings, adaptors, quick disconnect parts, compression fittings and vibration proofing joints. Designed for direct application onto as received parts where a light oily film exists or where surrounding parts contamination is a problem in maintenance

Useful Hint
 For fast cure, clean parts and apply local heat to joints with a heat gun or soft flame

Properties
 IAS69 is tolerant of a light oil film. Seals up to 400bar, 20mm fittings, and makes vibration proof joints

Procedure for Application
 Product is normally hand applied from the bottle. Ensure parts are clean, dry and free from oil and grease. Full cure in 12 hours

Compatible Accelerators / Primers
 IA471 Activator can be used, but up to 30% strength reduction may be incurred

Cured Performance
 ISO10964 Break/Prevailing Strgth.. 15/≥8 N.m
 DIN54454 Break/Prevail.. Strgth.24/15-35 N.m

Technical Features

Resin.....	Dimethacrylate
Colour.....	Brown
Cure Speed With Activator.....	<5 minutes
Cure Speed Without Activator...	10-20 minutes
Brookfield RVDVII + @ 20C.	
Spindle 5 @ 20rpm.....	400 to 800cps
Gap Fill.....	0.05mm to 0.25mm
Flash Point.....	>100°C
Shelf Life.....	12 months @ 20°C
Specific Gravity.....	1.06
Max Operating Temp.	-55°C to + 150°C

Sealing & Gasketing:

Product Codes:
IAS72 in 50 ml tube

Low Pressure Pipe Seal - White

Description
 IAS72 White Pipesal is an instant low pressure sealant for fine and coarse threads up to 2" in diameter. S72 does not fully cure until some 60 hours after application, allowing re-alignment of elbows and joints

Applications
 Replaces tapes and dopes, stops gas and fluid leaks on most metals and assists in lubricating during assembly. IAS72 will not shred or tear which would contaminate your system. Use IAS72 to seal against oils, gases, chemicals, water, steam etc.

Useful Hint
 Wipe threads with clean shop cloth. Apply a continuous bead to 3rd or 4th thread depending on the thread length

Properties
 Instantaneous low pressure seal. No locking action up to 48 hours. Easy break loose allowing re-alignment

Procedure for Application
 Ensure parts are clean, dry and free from oil and grease. Degreasing directly assists results

Compatible Accelerators / Primers
 Not recommended

Technical Features

Resin.....	Dimethacrylate
Colour.....	White Paste
Cure Speed w/ Activator...Not Recommended	
Cure Speed W/out Activator.....	Up to 60 hours
Viscosity	20,000cps
Gap Fill.....	0.4mm
Flash Point.....	>85°C
Shelf Life.....	12 months @ 20°C
Specific Gravity.....	1.25
Max Operating Temp.	-55°C to + 150°C

Sealing & Gasketing:

Product Code:
IAS55 in 50 ml tube

Designer Gasket - Purple Paste

Description
 Flange Seal Type IAS55 is a purple, smooth, thick paste. Easily applied, it cures once confined between the parts to form in place a tough, flexible gasket. IAS55 gives an instant low pressure seal

Applications
 IAS55 is used for fuel and water pumps, split crank cases on engines, gearbox covers, engine thermostats, air compressor end caps, engine timing cam covers onto blocks, pump couplings, fuel tanks on small implements, chainsaws, lawn mowers etc. Use IAS55 for dressing gaskets, spacers etc.

Useful Hints
 Where gap size is large or where the surface is uneven, apply IA471 Activator to help the product cure through volume. IAS55 can be roller coated, screen printed, traced or pad applied.

Properties
 Instant low pressure sealant. Forms any size or shape. Will not shrink or relax. IAS55 is flexible and will not crack

Procedure for Application
 Product is normally hand applied from the tube. Ensure parts are clean, dry and free from oil and grease

Compatible Accelerators / Primers
 IA471 Activator can be used, but up to 20% strength reduction may be incurred

Cured Performance

Full Cure Time.....	12 hours
Tensile Strength.....	8 N/mm ²
Static Shear Strength.....	12.5 N/mm ²

Technical Features

Resin.....	Modified Urethane Acrylate
Colour.....	Purple Paste
Cure Speed With Activator.....	<2 hours
Cure Speed Without Activator...	Up to 12 hours
Viscosity	>1,000,000cps
Gap Fill.....	0.5mm
Flash Point.....	>100°C
Shelf Life.....	12 months @ 20°C
Specific Gravity.....	1.10
Max Operating Temp.	-55°C to + 150°C

PROTECT

INDUSTRIAL ASSEMBLY PRODUCTS

REFER PIRTEK FOR MSDS SHEETS



IAS77-50

Sealing & Gasketing :

Product Codes:

IAS77 in 50 ml tube

High Strength Gas Pipe Seal - Yellow

Description

Protect IAS77 is a high viscosity thixotropic gel paste which cures rapidly, sealing instantly to 10 bar through its anaerobic cure system in contact with metals in the absence of air (oxygen). When fully cured it resists pressure up to 350 bar. IAS77 is not suitable for oxygen systems. AGA Certificate 6900

Applications

Typical applications are in sealing of all types of threaded connections against water, oil, gases and most common materials conveyed by pipes

Useful Hint

When cure speed is extended due to low temperatures or inactive surfaces, activator can be used. Best results are found if IAS77 is applied to 2nd or 3rd threadform. Excess can be wiped away, any migration into lines will not solidify and can be flushed away during commissioning

Properties

Fast cure to fixture usually <15 mins. @ 20°C

Temperature range: -50°C to +150°C

Typical Strength: 5 N/mm²

Sizes 6mm up to 75mm (coarse)

Increase of gap size or fit extends the cure time

Procedure for Application

Product is normally hand applied from the bottle. Ensure parts are clean, dry and free from oil and grease. Full cure 6-12 hours

Compatible Accelerators / Primers

IA471 Activator can be used, but up to 30% strength reduction may be incurred

Technical Features

Resin:Dimethacrylate

Colour:Yellow

Cure Speed with Activator:<10 minutes

Cure Speed w/o Activator:.....<15 mins @ 20°C

Viscosity:>50,000 cps

Gap Fill:0.05mm to 0.4mm

Flash Point:>100° C

Shelf Life:12 months @ 20°C

Specific Gravity:1.09

Max. Operating Temp.+150°C



IAS57-50

Sealing & Gasketing:

Product Codes:

IAS57 in 50 ml tube

PTFE Instant Pipe Sealant

Description

Protect IAS57 Instant Pipe Sealant is an easy to use anaerobic pipe sealant which sets fast to give an instant low pressure seal of 100 psi and a high pressure seal of 10000 psi when fully cured. This high strength product provides 100% sealing capability and does not shrink after curing, unlike more traditional solvent based pipe dopes.

Applications

IAS57 Instant Pipe Sealant with Teflon lubricates parts during assembly. The cure system allows for realignment of parts up to 24 hours from application. This product can be used on most hydraulic, pneumatic, oil, water and gas connections.

Useful Hint

Ensure parts are clean, dry and free from oil and grease.

Cured Performance

Full Cure Time:.....24 hours @ 20°C

Shear Strength.....10000 psi

Procedure for Application

Product is normally hand applied from the tube or brushed directly onto threaded parts. Primers such as IA471 (Standard Anaerobic Activator) can be used. However up to 20% strength loss can occur when using accelerators.

Technical Features

Resin Dimethacrylate

ColourWhite

Fixture Speed w/Activator.....<10mins

Fixture Speed w/out

Activator.....4 hour

Visco.....300,000 – 400,000cps

Gap Fill.....0.254mm

Shelf Life.....12 months @ 20°C

Max. Operating Temp.-54°C to + 200°C



IAR41-50

IAR41-10

Retaining:

Product Code:

IAR41 in 10 ml and 50 ml bottles

Medium Strength Bearing Fit - Yellow

Description

Bearing Fit IAR41 is a single part anaerobic securing compound, designed for fitting cylindrical metal assemblies and cures when confined between the parts

Applications

Protect IAR41 will secure all types and sizes of bearings, shafts and cylindrical parts which will require disassembly in the future. IAR41 is of medium strength and is colour coded yellow for job identification

Useful Hint

To speed cure or to help cure in cold conditions, use IA471 Activator on parts

Properties

Fast cure usually <15 mins. @ 20°C

Medium strength removable compound

Typical Strength: 12 N/mm²

Procedure for Application

Product is normally hand applied from the bottle. Ensure parts are clean, dry and free from oil and grease. Full cure 12 hours

Physical Properties

Standard Grade Solvent:.....Heptane Based

Resin.....Mod. Dimethacrylate

Colour.....Yellow

Cure Speed With Activator.....<5 minutes

Cure Speed Without Activator....10-15minutes

Viscosity.....1500 cps

Gap Fill.....0.2 mm

Flash Point.....>100°C

Shelf Life.....12 months @ 20 C

Specific Gravity.....1.06

Operating Temp.....-55°C to + 150°C



Consult Pirtek for MSDS Sheets for all Industrial Assembly Products

PROTECT

INDUSTRIAL ASSEMBLY PRODUCTS

REFER PIRTEK FOR MSDS SHEETS



Retaining :

Product Codes:
IAR62 in 10 ml and 50 ml bottles
High Strength / High Temperature

Description
 IAR62 Retainer is rated up to 232°C as the upper operational temperature and is designed for bonding/securing in a high strength manner, all types of cylindrically fitted parts

Applications
 Protect IAR62 is used on all types of applications where temperatures exceed the design features of conventional Retainers, above 150°C. It develops high strength at elevated temperatures.

Useful Hint
 Speed cure IAR62 by applying a localised heat with a heat gun or by placing parts in an oven @ 100°C for 30 minutes. Pre-heating of parts also accelerates the fixture and ultimate final cure

Properties
 Good gap fill ability. Elevated upper temperature limits. Resistant to 3000 psi shear

Procedure for Application
 Product is normally hand applied from the bottle. Ensure parts are clean, dry and free from oil and grease. Full cure in 24 hours

Compatible Accelerators / Primers
 IA471 Activator can be used, but up to 30% strength reduction may be incurred

Cured Performance
 Typical Breakaway Strength:.....20 N/mm²

Technical Features

Resin.....	Mod. Dimethacrylate
Colour.....	Green
Cure Speed With Activator.....	10 minutes
Cure Speed Without Activator.....	.30 minutes
Viscosity.....	7000 cps
Gap Fill.....	.0.4 mm max.
Flash Point.....	>85°C
Shelf Life.....	12 months @ 20 C
Specific Gravity.....	1.08
Max. Operating Temp.....	-55°C to + 232°C

Instant Bonding:

Product Codes:
IACA41 in 25 ml bottle
Quick Bonding

Description
 IACA41 is a hybrid quality Cyanoacrylate which is surface insensitive and bonds to a wide variety of materials including wood, paper, cardboard, leather, fabrics etc. Bond times vary according to the substrates but are generally faster than normal superglues

Applications
 Typical applications include wood trim on furniture, balsa wood bonding for hobbyists, leather accessories on shoes, fabric bows on shoes and lampshade bonding.

Other features include versatile bonding or most elastomers, metals and plastics

Useful Hint
 On elastomer bonding and some plastics, residues or release agents on surfaces should be removed by wiping with a solvent cleaner

Properties

Steel to Steel:.....	20 N/mm ²
Rubber to Rubber	10 N/mm ²
Plastic to Plastic	15 N/mm ²

Procedure for Application
 Ensure parts are clean, dry and free from oil and grease. Apply sparingly to one side and hold parts until handling strength is achieved (typically less than 15 seconds)

Compatible Accelerators / Primers
 Primers such as A021 or Double Strength A113 as accelerators for fillet cure for priming absorbent surfaces (available from Pirtek to order)

Technical Features

Resin.....	Modified Ethyl
Colour.....	Clear
Cure Speed W/ Activator..	Not Recommended
Cure Speed W/o Activator.....	<10 seconds
Viscosity.....	120cps
Gap Fill.....	.0.1mm
Flash Point.....	>85°C
Shelf Life.....	12 months @ 20°C
Specific Gravity.....	1.05
Operating Temp.	-60°C to + 80°C

Instant Bonding:

Product Code:
IACA60 in 25 ml bottle
High Strength Instant Adhesive

Description
 IACA60, when compared to other low viscosity Cyanoacrylates, outperforms most products for cure speed, final cured strength and simply the wide range of difficult plastics and elastomers it can bond

Applications
 For example, Nitrile, Neoprene and natural rubbers can be bonded in 1-2 seconds and all the bonds are stronger than the material itself. Plastics such as ABS, soft PVC, Polyacetal, EPT and EVA all bond in 1-2 seconds and the bonds are stronger than the material being bonded. Metals such as steel, aluminium, copper and brass all bond in under 5 seconds and the bond strengths are superior to other manufacturers low viscosity products

Useful Hints
 Slower cures of up to 12 seconds are found on Polymethyl Methacrylate (PMMA), Bakelite, Polycarbonate and Viton rubber. Polyolefins can be treated with special preparations. Consult Pirtek re Product Data Sheet 25 when dealing with these difficult plastics

Properties

Speed: Plastics (most)	<2 seconds
Rubbers (most)	<4 seconds
Metals	<5 seconds
Strength:.....Plastics to substrate failure	Rubbers to substrate failure
.....Metals >30 N/mm ² (Shear 15 N/mm ²)	

Procedure for Application
 For best results, degrease/abrade and make sure the surfaces are clean and free from dirt, dust and contamination such as mould release agents. Apply a thin film or drop to one surface only and bring parts together holding firmly for a few seconds until the parts achieve a handling strength. Remember one drop bonds about 25mm² and a 25 ml bottle has about 200 drops. 24 hours for full cure

Compatible Accelerators / Primers
 Primers such as A021 or Double Strength A113 as accelerators for fillet cure for priming absorbent surfaces (available from Pirtek to order)

Technical Features

Resin.....	Modified Ethyl CA
Colour.....	Clear
Cure Speed With Activator.....	Instant
Cure Speed Without Activator.....	1-5 seconds
Viscosity.....	20cps
Gap Fill.....	0.1 mm
Flash Point.....	>85°C
Shelf Life.....	12 months @ 20°C
Specific Gravity.....	1.06
Max. Operating Temperature.....	-60°C to + 90°C

PROTECT

INDUSTRIAL ASSEMBLY PRODUCTS

REFER PIRTEK FOR MSDS SHEETS



IATDS198



TDS198 EPOXY :

Product Codes:

IATDS198 in 180 mm x 20 mm Rod

Aluminium Stick - Epoxy Putty

Description

A hand kneadable, speciality epoxy putty that mixes in one minute to provide fast, permanent repairs to most aluminium surfaces. When applying it to surfaces it is necessary to work the material forcefully into the surface and apply pressure until adhesion begins to take effect. Lower temperature causes longer cure time. The handy rod form has the curing agent encapsulated in the contrasting colour base material. It's putty-like consistency eliminates drips and runs, providing "no mess" application with no tools required to use. The mixed epoxy turns from a silvery colour to "Alloy" upon curing and will not yellow upon exposure to UV light. After final cure, Aluminium Stick may be drilled, sawed, tapped, filed, sanded and painted. It allows patching in areas where welding is impossible

Applications

After proper mixing, Aluminium Stick moulds like clay and may be used to permanently patch dents, scratches, cuts, gouges and holes in items such as housings and all types of repairs to mouldings and injection type shapes. Aluminium Stick is ideal for making emergency repairs to reforming, rebuilding and patching anything made out of aluminium such as HVAC parts, refrigeration units, air conditioning units, machine parts, alu-roofing, flagpoles, shelving, platforms, walkways, campers, vehicles, canopies, gutters, truck bodies, wheels, manifolds, stripped threads, marine hardware and casings

Useful Hint

Mixing: Twist or cut off required amount. To mix, knead with fingers to a uniform colour. If mixing is difficult, warm the stick to room temperature or slightly above. Apply to the surface to be repaired (within 2 minutes of mixing). The mixed epoxy does not exhibit high bond strength at this point, but appears to be merely lying on the surface.

Force into any cracks or holes to be filled and strike off excess material, preferably with a tool wetted with clean water. Work the material forcefully into the surface and apply pressure until adhesion begins to take effect.

For a smooth appearance, hand rub with water or a damp cloth prior to hardening. Remove excess material before hardening begins. After 15-20 minutes the epoxy will harden like metal and start to form a tenacious bond. After just 45 minutes IATDS198 is completely cured and can be drilled, sawed, carved, sanded, stained or painted

Properties

Opening Time:	5 minutes
Max. Temp Resistance:	120°C (150°C intermittent)
Initial Cure:	1 hour max.
Full Cure Time:	24 hours
Lap Shear Strength (Steel):	4.8 N/mm ²
Shore D Hardness:	70/80
Compressive Strength:	84 N/mm ² - 12,000 psi

Procedure for Application

Surface should be cleaned free of grease or dirt. Scuffing or sanding the surface prior to cleaning helps to ensure a good bond

Technical Features

Resin:	Epoxy Light Silver
Epoxy Resistance:	Hydrocarbons, ketones, esters, halo-carbons, alcohols, aqueous salt solutions and dilute acids and bases
Electrical Resistance:	30,000 mega Ohms
Dielectric Strength (Steel):	300 Volts/mil
Shrinkage:	<1%
Non-Volatile Content:	100%
Shelf Life:	>6 months @ 25°C

IATDS252



TDS252 EPOXY:

Product Codes:

IATDS252 in 180 mm x 20 mm Rod

Steel Stick - Epoxy Putty

Description

Steel Stick is a hand kneadable, non rusting, steel reinforced epoxy putty that mixes in one minute to provide fast, permanent repairs to items made of ferrous and aluminium metals. It comes in a handy rod form with the curing agent encapsulated in the contrasting colour base material. It's putty-like consistency eliminates drips and runs, providing "no mess" application with no tools required to use. Steel Stick is black in colour after use.

Applications

After proper mixing, Steel Stick moulds like clay and may be used in many industrial and home Maintenance applications, including repair of iron pipes, tanks, tools and equipment, repair blow holes, holding and placement of fixtures and signs, repairs to moulds, patterns and castings, making prototypes, threadlocking, repair cracked castings, repairs to down spouts and gutters, light fixture installations, repairs to duct-work, anchor bolts, as well as countless other uses. The unused portion of Steel Stick will remain stable for years if protected from direct contact with the air, in cool conditions.

Useful Hint

Mixing: Twist or cut off required amount. To mix, knead with fingers to a uniform colour. If mixing is difficult, warm Steel Stick to room temperature or slightly above. Apply to the surface to be repaired (within 2 minutes of mixing). The mixed epoxy does not exhibit high bond strength at this point, but appears to be merely lying on the surface. Force into any cracks or holes to be filled and strike off excess material, preferably with a tool wetted with clean water. When applying to a damp, wet or slowly leaking area, work the material forcefully into the surface and apply pressure until adhesion begins to take effect. For a smooth appearance of the cured compound, hand rub with water or a damp cloth prior to hardening. Remove excess material before hardening begins. After 15-20 minutes the epoxy will harden like metal and start to form a tenacious bond. After just 45 minutes Steel Stick is completely cured and can be drilled, sawed, carved, sanded stained or painted.

Properties

Opening Time:	3.5 minutes
Max. Temperature Resistance:	120°C (150°C intermittent)
Initial Cure:	1 hour max.
Full Cure Time:	24 hours
Lap Shear Strength (Steel):	6.2 N/mm(2)
Shore D Hardness:	80
Compressive Strength:	84 N/mm(2) - 12,000 psi

Procedure for Application

Surface should be cleaned free of grease or dirt. Scuffing or sanding the surface prior to cleaning helps to ensure a good bond

Technical Features

Resin:	Epoxy
Chemical Resistance:	Hydrocarbons, ketones, esters, halo-carbons, aqueous salt solutions and dilute acids and bases
Electrical Resistance:	30,000 mega Ohms
Dielectric Strength (Steel):	300 Volts/mil
Shrinkage:	<1%
Non-Volatile Content:	100%
Shelf Life:	>6 months @ 25°C



This page is part of a complete catalogue containing technical and safety data. All data must be reviewed when selecting a product. Pirtek reserve the right to change technical specifications without notice.

PROTECT

INDUSTRIAL ASSEMBLY PRODUCTS

REFER PIRTEK FOR MSDS SHEETS



IASIL-300

Silicone Sealant:

Product Codes:

IASIL in 300 ml Tube
High Temperature Silicon - Black

Description

IASIL RTV Silicone is a one part, easily applied, paste-like sealant that cures to form a high purity elastomer on exposure to atmospheric moisture. No primers or accelerators are needed. When cured, it resists most chemicals, high temperatures and exhibits excellent mechanical properties

Applications

All applications where a non-sag sealant of exceptional longevity is required to bond glass, metals, ceramics, wood stone etc. IASIL eliminates leakage, reduces noise, absorbs vibration, seals and bonds parts into a secure unit.

Useful Hint

Where surfaces require only a single sided bond, it is possible to treat the side not requiring adhesion with a release agent or simply apply petroleum jelly or oil. When cured torque up the parts to form a compressive seal

Properties

Cure rate is 3mm in 24 hours but is humidity and temperature dependant. The rate of cure can be accelerated by increasing the temperature (70°C max.) and increasing the humidity levels

Procedure for Application

Product is normally hand applied from the cartridge. Ensure parts are clean, dry and free from oil and grease. Full cure in 24 hours

Compatible Accelerators / Primers

Products are available to order for difficult surfaces. Please consult Pirtek

Cured Performance

Full Cure Time:24 hours maximum
 Tensile Strength:200psi
 Hardness :35 Shore A
 Elongation :307%

Technical Features

Resin:Oxmie Silicone
 Colour:Black
 Cure Speed:Skin 5 mins
 Shelf Life:9-12 months unopened
 Specific Gravity:1.42
 Operating Temperature:-65°C to +260°C



IAAA-500

Aluminium Anti-Sieze Lubricants:

Product Codes:

IAAA 500g
Aluminium Anti-Sieze - High Temp. 871°C

Description

IAAA Aluminium-Graphite Anti-Seize paste consists of uniform, fine flaked particles in a special blend of lubricants and oils. It is ideal for use on a wide range of industrial products to prevent seizing, galling and excessive wear.

Applications

Can be used on nuts, bolts screws, pipe threads, O-rings, shafts and hubs. Typical applications include conveyor systems, gear boxes, chains, cams, u-joints, sprockets and tracking.

Protects up to 980°C

Prevents seizing and galling of metals

Protects against harsh and corrosive environments

Note that IAAA is not a high speed load carrying lubricant and is not recommended for ball or roller bearings.

On Part Performance

Temperature:.....-53°C up to 871°C
 Water Resistance:.....Excellent
 Corrosivity:.....Very Low
 Protection Level:.....Salt Water, Chemicals

Procedure for Application

Ensure parts are clean and dry, then simply apply by brush to provide instant protection.

Technical Features

Base:.....Highly Modified Synthetic Oil
 Additives:.....Copper, Graphite, Aluminium, Anti Corrosion Properties
 Shelf Life:.....1½ Years
 Consistency:.....Paste
 Viscosity120K - 175K
 Lubricity ..k Factor0.18
 Coefficient of Friction0.07 from 20°C - 760°C
 Specific Gravity:.....app 1.3
 Flash Point:.....>150°C
 Texture:.....Smooth Paste

Meets or exceeds the requirements of MIL-A-907E specification and conforms to GM -6108M



Consult Pirtek for MSDS Sheets for all Industrial Assembly Products

TECHNICAL DATA

CHEMICAL RESISTANCE TABLE - ANAEROBICS

AGENT	INDUSTRIAL ANAEROBIC				
	IAS55, IAS57	IAS69, IAS72, IAS77	IAR41, IAR62	IAT43	IAT77
Legend: G = Good C = Conditional U = Unsatisfactory - No Data					
Abrasive Coolant	G	G	G	G	G
Acetaldehyde	G	G	G	G	G
Acetate Solvents	G	G	G	G	G
Acetimide	G	G	G	G	G
Acetic Acid	G	G	G	G	G
Acetic Acid <10%	G	G	G	G	G
Acetic Acid >10%	-	-	-	G	-
Acetic Acid - Glacial	G	G	G	G	G
Acetic Anhydride	G	G	G	G	G
Acetone	G	G	G	G	G
Acetylene (Liq. Phase)	G	G	G	G	G
Acid Clay	G	G	G	G	G
Acrylic Acid	G	G	G	G	G
Acrylonitrile	G	G	G	G	G
Activated Alumina	G	G	G	G	G
Activated Carbon	G	G	G	G	G
Activated Silica	G	G	G	G	G
Alcohol - Allyl	G	G	G	G	G
Alcohol - Amyl	G	G	G	G	G
Alcohol - Benzyl	G	G	G	G	G
Alcohol - Butyl	G	G	G	G	G
Alcohol - Ethyl	G	G	G	G	G
Alcohol - Furfuryl	G	G	G	G	G
Alcohol - Hexyl	G	G	G	G	G
Alcohol - Isopropyl	G	G	G	G	G
Alcohol - Methyl	G	G	G	G	G
Alcohol - Propyl	G	G	G	G	G
Alum - Ammonium	G	G	G	G	G
Alum - Chrome	G	G	G	G	G
Alum - Potassium	G	G	G	G	G
Alum - Sodium	G	G	G	G	G
Alumina	G	G	G	G	G
Aluminium Acetate	G	G	G	G	G
Aluminium Bicarbonate	G	G	G	G	G
Aluminium Bifluoride	G	G	G	G	G
Aluminium Chloride	G	G	G	G	G
Aluminium Sulfate	G	G	G	G	G
Ammonia Anhydrous	U	U	U	U	U
Ammonia Solutions	U	U	U	U	U
Ammonium Bisulfite	G	G	G	G	G
Ammonium Borate	G	G	G	G	G
Ammonium Bromide	G	G	G	G	G
Ammonium Carbonate	G	G	G	G	G
Ammonium Chloride	G	G	G	G	G
Ammonium Chromate	G	G	G	G	G
Ammonium Fluoride	G	G	G	G	G
Ammonium Fluorosilicate	G	G	G	G	G
Ammonium Formate	G	G	G	G	G
Ammonium Hydroxide	G	G	G	G	G
Ammonium Hyposulfite	G	G	G	G	G
Ammonium Iodide	G	G	G	G	G
Ammonium Molybdate	G	G	G	G	G
Ammonium Nitrate	G	G	G	G	G
Ammonium Oxalate	G	G	G	G	G
Ammonium Persulfate	G	G	G	G	G
Ammonium Phosphate	G	G	G	G	G
Ammonium Picrate	G	G	G	G	G
Ammonium Sulfate	G	G	G	G	G
Amnim. Sulfate Scrubber	G	G	G	G	G
Ammonium Sulfide	G	G	G	G	G

AGENT	INDUSTRIAL ANAEROBIC				
	IAS55, IAS57	IAS69, IAS72, IAS77	IAR41, IAR62	IAT43	IAT77
Legend: G = Good C = Conditional U = Unsatisfactory - No Data					
Ammonium Thiocyanate	G	G	G	G	G
Amyl Acetate	G	G	G	G	G
Amyl Amine	G	G	G	G	G
Amyl Chloride	G	G	G	G	G
Aniline	G	G	G	G	G
Aniline Dyes	G	G	G	G	G
Anodizing Bath	G	G	G	G	G
Antichlor Solution	G	G	G	G	G
Antimony Acid Salts	G	G	G	G	G
Antimony Oxide	G	G	G	G	G
Antioxidant Gasoline	G	G	G	G	G
Aqua Regia	U	U	U	U	U
Argon	G	G	G	G	G
Armeen	G	G	G	G	G
Arochlor	G	G	G	G	G
Aromatic Gasoline	G	G	G	G	G
Aromatic Solvents	G	G	G	G	G
Arsenic Acid	G	G	G	G	G
Asbestos Slurry	G	G	G	G	G
Ash Slurry	G	G	G	G	G
Asphalt Emulsions	G	G	G	G	G
Asphalt Molten	G	G	G	G	G
Bagasse Fibers	G	G	G	G	G
Barium Acetate	G	G	G	G	G
Barium Carbonate	G	G	G	G	G
Barium Chloride	G	G	G	G	G
Barium Hydroxide <10%	G	G	G	G	G
Barium Hydroxide >10%	-	-	-	G	-
Barium Sulfate	G	G	G	G	G
Battery Acid <10%	G	G	G	G	G
Battery Acid >10%	-	-	-	G	-
Battery Diffuser Juice	G	G	G	G	G
Bauxite (See Alumina)	G	G	G	G	G
Bentonite	G	G	G	G	G
Benzaldehyde	G	G	G	G	G
Benzene	G	G	G	G	G
Benzene Hexachloride	G	G	G	G	G
Benzene-Hydrochloric Acid	G	G	G	G	G
Benzoic Acid	G	G	G	G	G
Benzotriazole	G	G	G	G	G
Beryllium Sulfate	G	G	G	G	G
Bicarbonate Liquor	G	G	G	G	G
Bilge Lines	G	G	G	G	G
Bleach Liquor	G	G	G	G	G
Bleached Pulp	G	G	G	G	G
Borax (S) Liquors	G	G	G	G	G
Boric Acid	G	G	G	G	G
Brake Fluids	G	G	G	G	G
Brine Chlorinated	G	G	G	G	G
Brine (Cold)	G	G	G	G	G
Bromine Solution	-	-	-	-	G
Butadiene	G	G	G	G	G
Butyl Acetate	G	G	G	G	G
Butyl Alcohol	G	G	G	G	G
Butyl Amine	G	G	G	G	G
Butyl Cellosolve (S)	G	G	G	G	G
Butyl Chloride	G	G	G	G	G
Butyl Ether (Dry)	G	G	G	G	G
Butyl Lactate	G	G	G	G	G
Butyl Resin	G	G	G	G	G

AGENT	INDUSTRIAL ANAEROBIC				
	IAS55, IAS57	IAS69, IAS72, IAS77	IAR41, IAR62	IAT43	IAT77
Legend: G = Good C = Conditional U = Unsatisfactory - No Data					
Butyraldehyde	G	G	G	G	G
Butyric Acid <10%	G	G	G	G	G
Butyric Acid >10%	-	-	-	G	-
Cadmium Chloride	G	G	G	G	G
Cadmium Plating Bath	G	G	G	G	G
Cadmium Sulfate	G	G	G	G	G
Calcium Acetate	G	G	G	G	G
Calcium Carbonate	G	G	G	G	G
Calcium Chlorate	G	G	G	G	G
Calcium Chloride	G	G	G	G	G
Calcium Chloride Brine	G	G	G	G	G
Calcium Citrate	G	G	G	G	G
Calcium Ferrocyanide	G	G	G	G	G
Calcium Formate	G	G	G	G	G
Calcium Hydroxide	G	G	G	G	G
Calcium Lactate	G	G	G	G	G
Calcium Nitrate	G	G	G	G	G
Calcium Phosphate	G	G	G	G	G
Calcium Silicate	G	G	G	G	G
Calcium Sulfamate	G	G	G	G	G
Calcium Sulfate	G	G	G	G	G
Calcium Sulfite	G	G	G	G	G
Camphor	G	G	G	G	G
Carbitol	G	G	G	G	G
Carbolic Acid (Phenol) <10%	G	G	G	G	G
Carbolic Acid (Phenol) >10%	-	-	-	G	-
Carbon Bisulfide	G	G	G	G	G
Carbon Black	G	G	G	G	G
Carbon Tetrachloride	G	G	G	G	G
Carbonic Acid <10%	G	G	G	G	G
Carbonic Acid >10%	-	-	-	G	-
Carbowax (S)	G	G	G	G	G
Carboxymethyl Cellulose	G	G	G	G	G
Carnauba Wax	G	G	G	G	G
Casein	G	G	G	G	G
Casein Water Paint	G	G	G	G	G
Celite	G	G	G	G	G
Cellosolve (S)	G	G	G	G	G
Cellulose Pulp	G	G	G	G	G
Cellulose Xanthate	G	G	G	G	G
Cement DryAir Blow	G	G	G	G	G
Cement Grout	G	G	G	G	G
Cement Slurry	G	G	G	G	G
Ceramic Enamel	G	G	G	G	G
Ceric Oxide	G	G	G	G	G
Chalk	G	G	G	G	G
Chemical Pulp	G	G	G	G	G
Chestnut Tanning	G	G	G	G	G
China Clay	G	G	G	G	G
Chloral Alcoholate	G	G	G	G	G
Chloramine	G	G	G	G	G
Chlorinated Hydrocarbons	G	G	G	G	G
Chlorinated Paperstock	G	G	G	G	G
Chlorinated Solvents	G	G	G	G	G
Chlor Sulphuric Acid	U	U	U	U	U
Chlorinated Wax	G	G	G	G	G
Chlorine Dioxide	U	U	U	U	U
Chlorine Liquid	U	U	U	U	U
Chlorine (Dry)	U	U	U	U	U



This page is part of a complete catalogue containing technical and safety data.
All data must be reviewed when selecting a product.
Pirtek reserve the right to change technical specifications without notice.

TECHNICAL DATA

CHEMICAL RESISTANCE TABLE - ANAEROBICS

AGENT	INDUSTRIAL ANAEROBIC				
	IAS55, IAS57	IAS69, IAS72, IAS77	IAR41, IAR62	IAT43	IAT77
Legend:					
G = Good					
C = Conditional					
U = Unsatisfactory					
- No Data					
Chloroacetic Acid <10%	G	G	G	G	G
Chloroacetic Acid >10%	-	-	-	G	-
Chlorobenzene (Dry)	G	G	G	G	G
Chlorosulfonic Acid	U	U	U	U	U
Chrome Acid Cleaning <10%	G	G	G	G	G
Chrome Acid Cleaning >10%	-	-	-	G	-
Chrome Liquor <10%	G	G	G	G	G
Chrome Liquor >10%	-	-	-	G	-
Chrome Plating Bath <10%	G	G	G	G	G
Chrome Plating Bath >10%	-	-	-	G	-
Chromic Acid 10%	G	G	G	G	G
Chromic Acid 50% (Cold)	U	U	U	U	U
Chromic Acid 50% (Hot)	U	U	U	U	U
Chromium Acetate	G	G	G	G	G
Chromium Chloride	G	G	G	G	G
Chromium Sulfate	G	G	G	G	G
Classifier	G	G	G	G	G
Clay	G	G	G	G	G
Coal Slurry	G	G	G	G	G
Coal Tar	G	G	G	G	G
Cobalt Chloride	G	G	G	G	G
Copper Amnium Formate	G	G	G	G	G
Copper Chloride	G	G	G	G	G
Copper Cyanide	G	G	G	G	G
Copper Naphthenate	G	G	G	G	G
Copper Plating(Acid Procs)	G	G	G	G	G
Copper Plating(Alk Procs)	G	G	G	G	G
Copper Sulfate	G	G	G	G	G
Core Oil	G	G	G	G	G
Corundum	G	G	G	G	G
Creosote	G	G	G	G	G
Creosote - Cresylic Acid	G	G	G	G	G
Cyanide Solution	G	G	G	G	G
Cyanuric Chloride	G	G	G	G	G
Cyclohexane	G	G	G	G	G
Cylinder Oils	G	G	G	G	G
De-Ionized Water	G	G	G	G	G
De-Ionized Water Low Conductivity	G	G	G	G	G
Detergents	G	G	G	G	G
Developer, photographic	G	G	G	G	G
Dextrin	G	G	G	G	G
Diacetone Alcohol	G	G	G	G	G
Diammonium Phosphate	G	G	G	G	G
Diamylamine	G	G	G	G	G
Diatomaceous Earth Slurr	G	G	G	G	G
Diazo Acetate	G	G	G	G	G
Dibutyl Ohthalate	G	G	G	G	G
Dichlorophenol	G	G	G	G	G
Dichloro Ethyl Ether	G	G	G	G	G
Dicyandamide	G	G	G	G	G
Dielectric Fluid	G	G	G	G	G
Diester Lubricants	G	G	G	G	G
Diethyl Ether Dry	G	G	G	G	G
Diethyl Sulfate	G	G	G	G	G
Diethylamine	G	G	G	G	G
Diethylene Glycol	G	G	G	G	G
Diglycolic Acid	G	G	G	G	G
Dimethyl Formamide	G	G	G	G	G
Dimethyl Sulfoxide	G	G	G	G	G

AGENT	INDUSTRIAL ANAEROBIC				
	IAS55, IAS57	IAS69, IAS72, IAS77	IAR41, IAR62	IAT43	IAT77
Legend:					
G = Good					
C = Conditional					
U = Unsatisfactory					
- No Data					
Dioxane Dry	G	G	G	G	G
Dioxidene	G	G	G	G	G
Dipentene - Pinene	G	G	G	G	G
Diphenyl	G	G	G	G	G
Distilled Water(Indust)	G	G	G	G	G
Dowtherm (S)	G	G	G	G	G
Drying Oil	G	G	G	G	G
Dust - Flue (Dry)	G	G	G	G	G
Dye Liquors	G	G	G	G	G
Emery - Slurry	G	G	G	G	G
Emulsified Oils	G	G	G	G	G
Enamel Frit Slip	G	G	G	G	G
Esters General	G	G	G	G	G
Ethyl Acetate	G	G	G	G	G
Ethyl Alcohol	G	G	G	G	G
Ethyl Amine	G	G	G	G	G
Ethyl Bromide	G	G	G	G	G
Ethyl Cellosolve (S)	G	G	G	G	G
Ethyl Cellosolve Slurry(S)	G	G	G	G	G
Ethyl Formate	G	G	G	G	G
Ethyl Silicate	G	G	G	G	G
Ethylene Diamine	G	G	G	G	G
Ethylene Dibromide	G	G	G	G	G
Ethylene Dichloride	G	G	G	G	G
Ethylene Glycol	G	G	G	G	G
Ethylenediamine T	G	G	G	G	G
Fatty Acids	G	G	G	G	G
Fatty Acids Amine	G	G	G	G	G
Fatty Alcohol	G	G	G	G	G
Ferric - Flocc	G	G	G	G	G
Ferric Chloride	G	G	G	G	G
Ferric Nitrate	G	G	G	G	G
Ferric Sulfate	G	G	G	G	G
Ferrocence - Oil Sol	G	G	G	G	G
Ferrous Chloride	G	G	G	G	G
Ferrous Oxalate	G	G	G	G	G
Ferrous Sulfate 10%	G	G	G	G	G
Ferrous Sulfate (Sat)	G	G	G	G	G
Fertilizer Sol	G	G	G	G	G
Flotation Concentrates	G	G	G	G	G
Fluoride Salts	G	G	G	G	G
Fluorine/Gaseous/Liquid	G	G	G	G	G
Fluorolube	G	G	G	G	G
Fluosilic Acid	G	G	G	G	G
Flux Soldering	G	G	G	G	G
Fly Ash Dry	G	G	G	G	G
Foam Latex Mix	G	G	G	G	G
Foamite	G	G	G	G	G
Formaldehyde (Cold)	G	G	G	G	G
Formaldehyde (Hot)	-	-	-	-	G
Formic Acid (Dil Cold)	G	G	G	G	G
Formic Acid (Dil Hot)	-	-	-	-	G
Formic Acid (Cold)	G	G	G	G	G
Formic Acid (Hot)	-	-	-	-	G
Freon (S)	-	-	-	-	G
Fuel Oil	G	G	G	G	G
Fuming Nitric Red	U	U	U	U	U
Fuming Sulfuric	U	U	U	U	U
Fuming Oleum	U	U	U	U	U
Furfural	G	G	G	G	G

AGENT	INDUSTRIAL ANAEROBIC				
	IAS55, IAS57	IAS69, IAS72, IAS77	IAR41, IAR62	IAT43	IAT77
Legend:					
G = Good					
C = Conditional					
U = Unsatisfactory					
- No Data					
Gallic Acid <5%	G	G	G	G	G
Gallic Acid >5%	-	-	-	G	-
Gallium Sulfate	G	G	G	G	G
Gasoline - Acid Wash	G	G	G	G	G
Gasoline - Alk Wash	G	G	G	G	G
Gasoline Aviation	G	G	G	G	G
Gasoline Copper Chloride	G	G	G	G	G
Gasoline Ethyl	G	G	G	G	G
Gasoline Motor	G	G	G	G	G
Gasoline Sour	G	G	G	G	G
Gasoline White	G	G	G	G	G
Gluconic Acid	G	G	G	G	G
Glue - Animal Gelatin	G	G	G	G	G
Glue - Plywood	G	G	G	G	G
Glutamic Acid	G	G	G	G	G
Glycerine Lye - Brine	U	U	U	U	U
Glycerol	G	G	G	G	G
Glycine	G	G	G	G	G
Glycine Hydrochloride	G	G	G	G	G
Glycol Amine	G	G	G	G	G
Glycolic Acid	G	G	G	G	G
Glyoxal	G	G	G	G	G
Gold Chloride	G	G	G	G	G
Gold Cyanide	G	G	G	G	G
Granodine	G	G	G	G	G
Grape Pomace Graphite	G	G	G	G	G
Grease Lubricating	G	G	G	G	G
Green Soap	G	G	G	G	G
Grinding Lubricant	G	G	G	G	G
Grit Steel	G	G	G	G	G
Gritty Water	G	G	G	G	G
Groundwood Stock	G	G	G	G	G
GRS Latex	G	G	G	G	G
Gum Paste	G	G	G	G	G
Gypsum	G	G	G	G	G
Halane Sol	G	G	G	G	G
Halogen Tin Plating	G	G	G	G	G
Halowax (S)	G	G	G	G	G
Harvel - Trans Oil	G	G	G	G	G
Heptane	G	G	G	G	G
Hexachlorobenzene	G	G	G	G	G
Hexadiene	G	G	G	G	G
Hexamethylenetetramine	G	G	G	G	G
Hexane	G	G	G	G	G
Hydrazine	G	G	G	G	G
Hydrazine Hydrate	G	G	G	G	G
Hydrobromic Acid <10%	G	G	G	G	G
Hydrobromic Acid >10%	-	-	-	G	-
Hydrochloric Acid	G	G	G	G	G
Hydrocyanic Acid <10%	G	G	G	G	G
Hydrocyanic Acid >10%	-	-	-	G	-
Hydrofluoric Acid	U	U	U	U	U
Hydrogen Peroxide (dil)	G	G	G	G	G
Hydrogen Peroxide(con)	-	-	-	-	G
Hydroponic Sol	G	G	G	G	G
Hydroquinone	G	G	G	G	G
Hypo	G	G	G	G	G
Hypochlorous Acid	G	G	G	G	G
Ink	G	G	G	G	G
Ink in Solvent - Printing	G	G	G	G	G

TECHNICAL DATA

CHEMICAL RESISTANCE TABLE - ANAEROBICS

AGENT	INDUSTRIAL ANAEROBIC				
	IAS55, IAS57	IAS69, IAS72, IAS77	IAR41, IAR62	IAT43	IAT77
Iodine in Alcohol	G	G	G	G	G
Iodine-Potassium Iodide	G	G	G	G	G
Iodine Solutions	G	G	G	G	G
Ion Exchange Service	G	G	G	G	G
Ion Exclusion Glycol	G	G	G	G	G
Irish Moss Slurry	G	G	G	G	G
Iron Ore Taconite	G	G	G	G	G
Iron Oxide	G	G	G	G	G
Isobutyl Alcohol	G	G	G	G	G
Isobutyraldehyde	G	G	G	G	G
Isocetane	G	G	G	G	G
Isopropyl Alcohol	G	G	G	G	G
Isocyanate Resin	G	G	G	G	G
Isopropyl Acetate	G	G	G	G	G
Isopropyl Ether	G	G	G	G	G
Itaconic Acid	G	G	G	G	G
Jet Fuels	G	G	G	G	G
Jewelers Rouge	G	G	G	G	G
Jig Table Slurry	G	G	G	G	G
Kaolin - China Clay (S)	G	G	G	G	G
Kelp Slurry	G	G	G	G	G
Kerosense	G	G	G	G	G
Kerosene Chlorinated	G	G	G	G	G
Ketone	G	G	G	G	G
Lacquer Thinner	G	G	G	G	G
Lactic Acid	G	G	G	G	G
Lapping Compound	G	G	G	G	G
Latex - Natural	G	G	G	G	G
Latex - Synthetic	G	G	G	G	G
Latex Synthetic Raw	G	G	G	G	G
Laundry Wash Water	G	G	G	G	G
Laundry Bleach	G	G	G	G	G
Laundry Blue	G	G	G	G	G
Laundry Soda	G	G	G	G	G
Lead Arsenate	G	G	G	G	G
Lead Oxide	G	G	G	G	G
Lead Sulfate	G	G	G	G	G
Lignin Extract	G	G	G	G	G
Lime Slaked	G	G	G	G	G
Lime Sulfur Mix	G	G	G	G	G
Liquid Ion Exchange	G	G	G	G	G
Lithium Chloride	G	G	G	G	G
LOX (Liquid O2)	U	U	U	U	U
Ludox	G	G	G	G	G
Lye	U	U	U	U	U
Machine Coating Colour	G	G	G	G	G
Magnesite Slurry	G	G	G	G	G
Magnesite	G	G	G	G	G
Magnesium Bisulfite	G	G	G	G	G
Magnesium Carbonate	G	G	G	G	G
Magnesium Chloride	G	G	G	G	G
Magnesium Hydroxide	G	G	G	G	G
Magnesium Sulfate	G	G	G	G	G
Maleic Acid	G	G	G	G	G
Maleic Anhydride	G	G	G	G	G
Manganese Chloride	G	G	G	G	G
Manganese Sulfate	G	G	G	G	G
Melamine Resin	G	G	G	G	G
Menthol	G	G	G	G	G
Mercaptans	G	G	G	G	G

AGENT	INDUSTRIAL ANAEROBIC				
	IAS55, IAS57	IAS69, IAS72, IAS77	IAR41, IAR62	IAT43	IAT77
Mercuric Chloride	G	G	G	G	G
Mercuric Nitrate	G	G	G	G	G
Mercury	G	G	G	G	G
Mercury Dry	G	G	G	G	G
Methane	G	G	G	G	G
Methyl Alcohol	G	G	G	G	G
Methyl Acetate	G	G	G	G	G
Methyl Bromide	G	G	G	G	G
Methyl Carbitol	G	G	G	G	G
Methyl Cellosolve (S)	G	G	G	G	G
Methyl Chloride	G	G	G	G	G
Methyl Ethyl Ketone	G	G	G	G	G
Methyl Isobutyl Ketone	G	G	G	G	G
Methyl Lactate	G	G	G	G	G
Methyl Orange	G	G	G	G	G
Methylamine	G	G	G	G	G
Methylene Chloride	G	G	G	G	G
Mineral Spirits	G	G	G	G	G
Mixed Acid/Nitric/Sulfuric	U	U	U	U	U
Monochloroacetic Acid	G	G	G	G	G
Morpholine	G	G	G	G	G
Mud	G	G	G	G	G
Nalco Sol	G	G	G	G	G
Naphtha	G	G	G	G	G
Naphthalene	G	G	G	G	G
Naval Stores Solvent	G	G	G	G	G
Nematocide	G	G	G	G	G
Neoprene Emulsion	G	G	G	G	G
Neoprene Latex	G	G	G	G	G
Nickel Acetate	G	G	G	G	G
Nickel Ammonium Sulfate	G	G	G	G	G
Nickel Chloride	G	G	G	G	G
Nickel Cyanide	G	G	G	G	G
Nickel Fluoborate	G	G	G	G	G
Nickel Ore Fines	G	G	G	G	G
Nickel Plating Bright	G	G	G	G	G
Nickel Sulfate	G	G	G	G	G
Nicotinic Acid <10%	G	G	G	G	G
Nicotinic Acid >10%	-	-	-	G	-
Nitrate Sol	G	G	G	G	G
Nitration Acid(s)	U	U	U	U	U
Nitric Acid	U	U	U	U	U
Nitric Acid <10%	G	G	G	G	G
Nitric Acid 10%	-	-	-	G	-
Nitric Acid 20%	-	-	-	-	G
Nitric Acid Anhydrous	U	U	U	U	U
Nitric Acid Fuming	U	U	U	U	U
Nitro Aryl Sulfonic Acid	G	G	G	G	G
Nitrobenzene - Dry	G	G	G	G	G
Nitrocellulose	G	G	G	G	G
Nitrofurane	G	G	G	G	G
Nitroguanidine	G	G	G	G	G
Nitroparaffins - Dry	G	G	G	G	G
Nitrosyl Chloride	G	G	G	G	G
Norite Carbon	G	G	G	G	G
Nuchar	G	G	G	G	G
Oakite (S) Compound	G	G	G	G	G
Oil, Creosote	G	G	G	G	G
Oil, Emulsified	G	G	G	G	G
Oil, Fuel	G	G	G	G	G

AGENT	INDUSTRIAL ANAEROBIC				
	IAS55, IAS57	IAS69, IAS72, IAS77	IAR41, IAR62	IAT43	IAT77
Oil, Lubricating	G	G	G	G	G
Oil, Soluble	G	G	G	G	G
Oleic Acid (Hot)	G	G	G	G	G
Oleic Acid (Cold)	G	G	G	G	G
Ore Fines - Flotation	G	G	G	G	G
Ore Pulp	G	G	G	G	G
Organic Dyes	G	G	G	G	G
Oxalic Acid (Cold)	G	G	G	G	G
Ozone (Wet)	U	U	U	U	U
Paint - Linseed Base	G	G	G	G	G
Paint - Water Base	G	G	G	G	G
Paint - Remover - Sol Type	G	G	G	G	G
Paint - Vehicles	G	G	G	G	G
Palmitic Acid	G	G	G	G	G
Paper Board Mill Waste	G	G	G	G	G
Paper Coating Slurry	G	G	G	G	G
Paper Pulp	G	G	G	G	G
Paper Pulp with Amun	G	G	G	G	G
Paper Pulp with Dye	G	G	G	G	G
Paper Pulp, bleached	G	G	G	G	G
Paper Pulp, bleach - washed	G	G	G	G	G
Paper Pulp Chlorinated	G	G	G	G	G
Paper Groundwood	G	G	G	G	G
Paper Rag	G	G	G	G	G
Paper Stocks, Fine	G	G	G	G	G
Paradichlorobenzene	G	G	G	G	G
Paraffin Molten	G	G	G	G	G
Paraffin Sion	G	G	G	G	G
Paraformaldehyde	G	G	G	G	G
Pectin Solution Acid	G	G	G	G	G
Pentachlorethane	G	G	G	G	G
Pentaerythritol Sol	G	G	G	G	G
Perchlorethylene (Dry)	G	G	G	G	G
Perchloric Acid <10%	G	G	G	G	G
Perchloric Acid >10%	-	-	-	G	-
Perchloromethyl Mercaptan	G	G	G	G	G
Permanganic Acid	U	U	U	U	U
Persulfuric Acid	U	U	U	U	U
Petroleum Ether	G	G	G	G	G
Petroleum Jelly	G	G	G	G	G
Phenol Formaldehyde Resins	G	G	G	G	G
Phenolic Glue	G	G	G	G	G
Phloroglucinol	G	G	G	G	G
Phosphate Ester	G	G	G	G	G
Phosphatic Sand	G	G	G	G	G
Phosphoric Acid 85% (Hot)	U	U	U	U	U
Phosphoric Acid 85% (Cold)	-	-	-	-	G
Phosphoric Acid 50% (Hot)	-	-	-	-	G
Phosphoric Acid 50% (Cold)	-	-	-	-	G
Phosphoric Acid 10% (Hot)	-	-	-	-	G
Phosphoric Acid 10% (Cold)	G	G	G	G	G
Phosphorous Molten	G	G	G	G	G
Phosphotungstic Acid	G	G	G	G	G
Photographic Sol	G	G	G	G	G
Phthalic Acid	G	G	G	G	G
Phytate	G	G	G	G	G
Phytate Salts	G	G	G	G	G
Pickling Acid, Sulfuric	G	G	G	G	G
Picric Acid Solutions	G	G	G	G	G
Pine Oil Finish	G	G	G	G	G



This page is part of a complete catalogue containing technical and safety data. All data must be reviewed when selecting a product. Pirtek reserve the right to change technical specifications without notice.

TECHNICAL DATA

CHEMICAL RESISTANCE TABLE - ANAEROBICS

AGENT	INDUSTRIAL ANAEROBIC				
	IAS55, IAS57	IAS69, IAS72, IAS77	IAR41, IAR62	IAT43	IAT77
Legend:					
G = Good					
C = Conditional					
U = Unsatisfactory					
- No Data					
Plating Sol As follows:	G	G	G	G	G
Brass Cyanide	G	G	G	G	G
Bronze - Cyanide	G	G	G	G	G
Chromium/Cadmium Cyanide	G	G	G	G	G
Cobalt Acid	G	G	G	G	G
Copper Acid	G	G	G	G	G
Gold Cyanide	G	G	G	G	G
Iron - Acid	G	G	G	G	G
Lead - Fluoro	G	G	G	G	G
Nickel Bright	G	G	G	G	G
Platinum	G	G	G	G	G
Silver - Cyanide	G	G	G	G	G
Tin - Acid	G	G	G	G	G
Tin Alk Barrel	G	G	G	G	G
Zinc Acid	G	G	G	G	G
Zinc Alk Cyanide	G	G	G	G	G
Polycrylonitrile Slurry	G	G	G	G	G
Polypentek	G	G	G	G	G
Polysulfide Liquor	G	G	G	G	G
Polyvinyl Acetate Slurry	G	G	G	G	G
Polyvinyl Chloride	G	G	G	G	G
Porcelain Frit	G	G	G	G	G
Potash <10%	G	G	G	G	G
Potash >10%	-	-	-	G	-
Potassium Acetate	G	G	G	G	G
Potassium Alum Sulfate	G	G	G	G	G
Potassium Bromide	G	G	G	G	G
Potassium Carbonate	G	G	G	G	G
Potassium Chlorate	G	G	G	G	G
Potassium Chloride Sol	G	G	G	G	G
Potassium Chromate	G	G	G	G	G
Potassium Cyanide Sol	G	G	G	G	G
Potassium Dichromate	G	G	G	G	G
Potassium Ferricyanide	G	G	G	G	G
Potassium Hydroxide	U	U	U	U	U
Potassium Iodide	G	G	G	G	G
Potassium Nitrate	G	G	G	G	G
Potassium Perchlorate	G	G	G	G	G
Potassium Permanganate	G	G	G	G	G
Potassium Persulfate	G	G	G	G	G
Potassium Phosphate	G	G	G	G	G
Potassium Silicate	G	G	G	G	G
Potassium Sulfate	G	G	G	G	G
Potassium Xanthate	G	G	G	G	G
Press Board Waste	G	G	G	G	G
Propionic Acid	G	G	G	G	G
Propyl Alcohol	G	G	G	G	G
Propyl Bromide	G	G	G	G	G
Propylene Glycol	G	G	G	G	G
Pumice	G	G	G	G	G
Pyranol	G	G	G	G	G
Pyridine	G	G	G	G	G
Pyrogallic Acid	G	G	G	G	G
Pyrogen Free Water	G	G	G	G	G
Pyrole	G	G	G	G	G
Pyromellitic Acid	G	G	G	G	G
Quebracho Tannin	G	G	G	G	G
Rag Stock Bleached	G	G	G	G	G
Rare Earth Salts	G	G	G	G	G
Rayon Acid Water	G	G	G	G	G

AGENT	INDUSTRIAL ANAEROBIC				
	IAS55, IAS57	IAS69, IAS72, IAS77	IAR41, IAR62	IAT43	IAT77
Legend:					
G = Good					
C = Conditional					
U = Unsatisfactory					
- No Data					
Rayon Spin Bath	G	G	G	G	G
Rayong Spin Bath spent	G	G	G	G	G
Resorcinol	G	G	G	G	G
River Water	G	G	G	G	G
Road Oil	G	G	G	G	G
Roccal	G	G	G	G	G
Rosin - Wood	G	G	G	G	G
Rosin in Alcohol	G	G	G	G	G
Rosin Size	G	G	G	G	G
Rubber Latex	G	G	G	G	G
Safrole	G	G	G	G	G
Salt Alkaline	G	G	G	G	G
Salt Electrolytic	G	G	G	G	G
Salt Refrg	G	G	G	G	G
Sand - Air Brown Slurry	G	G	G	G	G
Sand - Air Phosphatic	G	G	G	G	G
Sea Coal	G	G	G	G	G
Sea Water	G	G	G	G	G
Selenium Chloride	G	G	G	G	G
Sequestrene	G	G	G	G	G
Sewage	G	G	G	G	G
Shellac	G	G	G	G	G
Shower Water	G	G	G	G	G
Silica Gel	G	G	G	G	G
Silica Ground	G	G	G	G	G
Silicone Tetrachloride	G	G	G	G	G
Silicone Fluids	G	G	G	G	G
Silver Cyanide	G	G	G	G	G
Silver Iodide - Aqu	G	G	G	G	G
Silver Nitrate	G	G	G	G	G
Size Emulsion	G	G	G	G	G
Skelly Solve EL	G	G	G	G	G
Slate to 400 Mesh	G	G	G	G	G
Soap Lye	U	U	U	U	U
Soap Solutions(Stearates)	G	G	G	G	G
Soap Stone Air Blown	G	G	G	G	G
Soda Pulp	G	G	G	G	G
Sodium Acetate	G	G	G	G	G
Sodium Acid Fluoride	G	G	G	G	G
Sodium Aluminate	G	G	G	G	G
Sodium Arsenate	G	G	G	G	G
Sodium Benzene Sulfonate	G	G	G	G	G
Sodium Bichromate	G	G	G	G	G
Sodium Bisulfite	G	G	G	G	G
Sodium Bromide	G	G	G	G	G
Sodium Carbonate	G	G	G	G	G
Sodium Chlorate	G	G	G	G	G
Sodium Chlorite	G	G	G	G	G
Sodium Cyanide	G	G	G	G	G
Sodium Ferricyanide	G	G	G	G	G
Sodium Formate	G	G	G	G	G
Sodium Glutamate	G	G	G	G	G
Sodium Hydrogen Sulfate	G	G	G	G	G
Sodium Hydrosulfite	G	G	G	G	G
Sodium Hydrosulfide	G	G	G	G	G
Sodium Hydrochloride	G	G	G	G	G
Sodium Hydro 20% (Cold)	G	G	G	G	G
Sodium Hydro 20% (Hot)	-	-	-	-	G
Sodium Hydro 50% (Cold)	-	-	-	-	G
Sodium Hydro 50% (Hot)	U	U	U	U	U

AGENT	INDUSTRIAL ANAEROBIC				
	IAS55, IAS57	IAS69, IAS72, IAS77	IAR41, IAR62	IAT43	IAT77
Legend:					
G = Good					
C = Conditional					
U = Unsatisfactory					
- No Data					
Sodium Hydro 70% (Cold)	-	-	-	-	G
Sodium Hydro 70% (Hot)	U	U	U	U	U
Sodium Hypochlorite	G	G	G	G	G
Sodium Lignosulfonate	G	G	G	G	G
Sodium Metasilicate	G	G	G	G	G
Sodium Molten	G	G	G	G	G
Sodium Nitrate	G	G	G	G	G
Sodium Nitrite - Nitrate	G	G	G	G	G
Sodium Perborate	G	G	G	G	G
Sodium Peroxide	U	U	U	U	U
Sodium Persulfate	G	G	G	G	G
Sodium Phosphate - Mono	G	G	G	G	G
Sodium Phosphate - Tri	G	G	G	G	G
Sodium Potassium Chloride	G	G	G	G	G
Sodium Salicylate	G	G	G	G	G
Sodium Sessquicarbonate	G	G	G	G	G
Sodium Silicate	G	G	G	G	G
Sodium Silcofluoride	G	G	G	G	G
Sodium Stannate	G	G	G	G	G
Sodium Sulfate	G	G	G	G	G
Sodium Sulfide	G	G	G	G	G
Sodium Sulfite	G	G	G	G	G
Sodium Thiocyanate	G	G	G	G	G
Sodium Thiosulfate	G	G	G	G	G
Sodium Tungstate	G	G	G	G	G
Sodium Xanthate	G	G	G	G	G
Solox - Denat Ehtanol	G	G	G	G	G
Soluble Oil	G	G	G	G	G
Solvent Naphthas	G	G	G	G	G
Sorbic Acid	G	G	G	G	G
Sour Gasoline	G	G	G	G	G
Soybean Sludge - Acid	G	G	G	G	G
Spensol Solution	G	G	G	G	G
Stannic Chloride	G	G	G	G	G
Starch	G	G	G	G	G
Starch base	G	G	G	G	G
Stearic Acid	G	G	G	G	G
Steep Water	G	G	G	G	G
Sterilization Steam	G	G	G	G	G
Stillage Distillers	G	G	G	G	G
Stoddard Solvent	G	G	G	G	G
Styrene	G	G	G	G	G
Styrene Butadiene Latex	G	G	G	G	G
Sulfamic Acid	G	G	G	G	G
Sulfan - Sulfuric Anhydride	G	G	G	G	G
Sulfathiazole	G	G	G	G	G
Sulfite Liquor	G	G	G	G	G
Sulfite Stock	G	G	G	G	G
Sulfonated Oils	G	G	G	G	G
Sulfones	G	G	G	G	G
Sulfonic Acids	G	G	G	G	G
Sulfonyl Chloride	G	G	G	G	G
Sulfur Slurry	G	G	G	G	G
Sulfur Solution	G	G	G	G	G
in Carbon Disulfide	G	G	G	G	G
Sulphuric Acid 0 - 7%	-	-	-	-	G
Sulphuric Acid 7 - 40%	-	-	-	-	G
Sulphuric Acid 40 - 75%	U	U	U	U	U
Sulphuric Acid 75 - 95%	U	U	U	U	U
Sulphuric Acid 95 - 100%	-	-	-	-	G



TECHNICAL DATA

CHEMICAL RESISTANCE TABLE - ANAEROBICS

AGENT	INDUSTRIAL ANAEROBIC				
	IAS55, IAS57	IAS69, IAS72, IAS77	IAR41, IAR62	IAT43	IAT77
Legend: G = Good C = Conditional U = Unsatisfactory - No Data					
Sulphurous Acid	-	-	-	-	G
Sulfuryl Chloride	G	G	G	G	G
Surfactants	G	G	G	G	G
Synthetic Latex	G	G	G	G	G
Tactonite - Fines	G	G	G	G	G
Talc - Slurry	G	G	G	G	G
Tankage - Slurry	G	G	G	G	G
Tannic Acid (Cold)	-	-	-	-	G
Tarmin	G	G	G	G	G
Tar & Tar Oil	G	G	G	G	G
Tartaric Acid	G	G	G	G	G
Television Chemicals	G	G	G	G	G
Tergitol (S)	G	G	G	G	G
Terpineol	G	G	G	G	G
Tetraethyl Lead	G	G	G	G	G
Tetrahydrofuran	G	G	G	G	G
Tetranitromethane	G	G	G	G	G
Textile Dyeing	G	G	G	G	G
Textile Finishing Oil	G	G	G	G	G
Textile Printing Oil	G	G	G	G	G
Thiocyanic Acid	G	G	G	G	G
Thioglycolic Acid	G	G	G	G	G
Thionyl Chloride	G	G	G	G	G
Thiophosphoryl Chloride	G	G	G	G	G
Thiourea	G	G	G	G	G
Thorium Nitrate	G	G	G	G	G
Thymol	G	G	G	G	G
Tin Tetrachloride	G	G	G	G	G
Tinning Sol DuPont	G	G	G	G	G
Titania Paper Coating	G	G	G	G	G
Titanium Oxide Slurry	G	G	G	G	G
Titanium Oxy Sulfate	G	G	G	G	G
Titanium Sulfate	G	G	G	G	G
Titanium Tetrachloride	G	G	G	G	G
Toluol	G	G	G	G	G
Toluene	G	G	G	G	G
p - Toluene Sulfonic Acid	-	-	-	-	G
Transil Oil	G	G	G	G	G
Trichloroacetic Acid	G	G	G	G	G
Trichloroethane 1,1,1	G	G	G	G	G
Trichlorethylene	G	G	G	G	G
Trichlorethylene - Dry	G	G	G	G	G
Tricresyl Phosphate	G	G	G	G	G
Triethanolamine	G	G	G	G	G
Triethylene Glycol	G	G	G	G	G
Trioxane	G	G	G	G	G
Tungstic Acid	G	G	G	G	G
Turpentine	G	G	G	G	G
UCON (S) Lube	G	G	G	G	G
Udylite Bath - Nickel	G	G	G	G	G
Undecylenic Acid	G	G	G	G	G
Unichrome Sol Alk	G	G	G	G	G
Uranium Salts	G	G	G	G	G
Uranyl Nitrate	G	G	G	G	G
Uranyl Sulfate	G	G	G	G	G
Urea Ammonia Liquor	G	G	G	G	G
Vacuum to 100 Micron	G	G	G	G	G
Vacuum 100 Micron	G	G	G	G	G
Vacuum Oil	G	G	G	G	G
Vanadium Pentoxide	G	G	G	G	G

AGENT	INDUSTRIAL ANAEROBIC				
	IAS55, IAS57	IAS69, IAS72, IAS77	IAR41, IAR62	IAT43	IAT77
Legend: G = Good C = Conditional U = Unsatisfactory - No Data					
Slurry	G	G	G	G	G
Varnish	G	G	G	G	G
Varsol - Naphtha Solv	G	G	G	G	G
Versene (S)	G	G	G	G	G
Vinyl Acetate Dry or	G	G	G	G	G
Chloride Monomer	G	G	G	G	G
Vinyl Chloride Latex Emul	G	G	G	G	G
Vinyl Resin Slurry	G	G	G	G	G
Viscose	G	G	G	G	G
Vortex - Hydroclone	G	G	G	G	G
Water - Acid Below pH7	G	G	G	G	G
Water pH7 to 8	G	G	G	G	G
Water Alkaline-Over pH8	G	G	G	G	G
Water Mine Water	G	G	G	G	G
Water Potable	-	-	-	G	-
Water River	G	G	G	G	G
Water Sandy	G	G	G	G	G
Water 'White' low pH	G	G	G	G	G
Water 'White' high pH	G	G	G	G	G
Wax Chlorinated	G	G	G	G	G
Wax Emulsions	G	G	G	G	G
Weed Killer Dirbromide	G	G	G	G	G
Weisberg Sulfate Plating	G	G	G	G	G
Wood ground pulp	G	G	G	G	G
Wort Lines	G	G	G	G	G
X - Ray Developing Bath	G	G	G	G	G
Xylene	G	G	G	G	G
Zelan	G	G	G	G	G
Zeolite Water	G	G	G	G	G
Zinc Acetate	G	G	G	G	G
Zinc Bromide	G	G	G	G	G
Zinc Chloride	G	G	G	G	G
Zinc Cyanide - Alk	G	G	G	G	G
Zinc Fines Slurry	G	G	G	G	G
Zinc Flux Paste	G	G	G	G	G
Zinc Galvanizing	G	G	G	G	G
Zinc Hydrosulfite	G	G	G	G	G
Zinc Oxide in Water	G	G	G	G	G
Zinc Oxide in Oil	G	G	G	G	G
Zinc Sulfate	G	G	G	G	G
Zincolate	G	G	G	G	G
Zirconyl Nitrate	G	G	G	G	G
Zirconyl Sulfate	G	G	G	G	G

GASES	INDUSTRIAL ANAEROBIC				
	IAS55, IAS57	IAS69, IAS72, IAS77	IAR41, IAR62	IAT43	IAT77
Legend: G = Good C = Conditional U = Unsatisfactory - No Data					
Acetylene	G	G	G	G	G
Acid & Alkali Vapors	G	G	G	G	G
Air	G	G	G	G	G
Amine	G	G	G	G	G
Ammonia	G	G	G	G	G
Butane	G	G	G	G	G
Butadiene Gas/Liquid	G	G	G	G	G
Butylene Gas/Liquid	G	G	G	G	G
By-Product Gas (Dry)	G	G	G	G	G
Carbon Dioxide	G	G	G	G	G
Carbon Disulfide	G	G	G	G	G
Carbon Monoxide	G	G	G	G	G
Chloride (Dry)	G	G	G	G	G
Chlorine (Dry)	U	U	U	U	U
Chlorine (Wet)	U	U	U	U	U
Coke-Oven Gas (Cold)	G	G	G	G	G
Coke-Oven Gas (Hot)	-	-	-	-	G
Cyanogen Chloride	G	G	G	G	G
Cyanogen Gas	G	G	G	G	G
Ethane	G	G	G	G	G
Ether-see Diethyl Ether	G	G	G	G	G
Ethylene	G	G	G	G	G
Ethylene Oxide	G	G	G	G	G
Freon (S) (11-12-21-22)	-	-	-	-	G
Furnace Gas (Cold)	-	-	-	-	G
Furnace Gas (Hot)	G	G	G	G	G
Gas Drip Oil	G	G	G	G	G
Gas Flue	G	G	G	G	G
Gas Manufacturing	G	G	G	G	G
Gas Natural	G	G	G	G	G
Helium	G	G	G	G	G
Hydrogen Gas - Cold	G	G	G	G	G
Hydrogen Chloride	G	G	G	G	G
Hydrogen Cyanide	G	G	G	G	G
Hydrogen Sulfide-W/D	G	G	G	G	G
Isobutane	G	G	G	G	G
Methane	G	G	G	G	G
Methyl Chloride	G	G	G	G	G
Natural Gas - Dry	G	G	G	G	G
Nitrogen Gas	G	G	G	G	G
Nitrous Oxide	G	G	G	G	G
Oil - Solvent Vapor	G	G	G	G	G
Oxygen	U	U	U	U	U
Ozone	U	U	U	U	U
Producer Gas 50 PSI	G	G	G	G	G
Propane	G	G	G	G	G
Propylene	G	G	G	G	G
Steam H Pressure ("70 psi)	U	U	U	U	U
Steam L Pressure ("70 psi)	G	G	G	G	G
Sulfur Dioxide	G	G	G	G	G
Sulfure Dioxide Dry	G	G	G	G	G
Sulfur Trioxide Gas	G	G	G	G	G
Sulfuric Acid Vapor	U	U	U	U	U



GRAB KIT CASES



COMPARTMENT STORAGE CASE



Versatile storage system for the transfer and handling of various components. Ideal for use as a grab kit to store brassware, O-rings, adaptors, fittings, clamps, nuts & bolts.

Manufactured from strong engineering polymers & uses stainless steel hinge and latch springs to ensure extended product life. Includes 6 dividers plus 1 compartment in front of case.

- Corrosion proof
- Lid opens 180°
- Sturdy locking system
- Divided goods will not interchange when shaken
- Unique lid design keeps storage locked in place
- Additional dividers available to create up to 20 compartments

Part Number	Dimensions mm		
GKC-01	W = 370	D = 370	H = 85
GKD	Individual Divider		

CABINET



2 or 3 drawer cabinet which can be joined vertically and or horizontally. Cabinet can be fixed to bench, racking or vehicle floor.

These cabinets only suit Pirtek compartment storage case & Pirtek Pressure test kit cases.

Part Number	Description	Dimensions mm		
RC2DC †	2 Drawer cabinet	W = 419	D = 460	H = 250
RC3DC †	3 Drawer cabinet	W = 419	D = 460	H = 350

† Non-Stocked Item, available on request

FRAME



2 or 3 drawer frame which can be fixed to any vehicle, wall, bench or shelf. These frames only suit Pirtek compartment storage case & Pirtek Pressure test kit cases.

Part Number	Description	Dimensions mm		
RC2FR †	2 Drawer frame	W = 419	D = 460	H = 250
RC3FR †	3 Drawer frame	W = 419	D = 460	H = 350

† Non-Stocked Item, available on request

AUTOMOTIVE HOSES

PACKAGED SPOOLS
FOR WORKSHOP & HOME



P3111

AUTO
FUEL HOSE

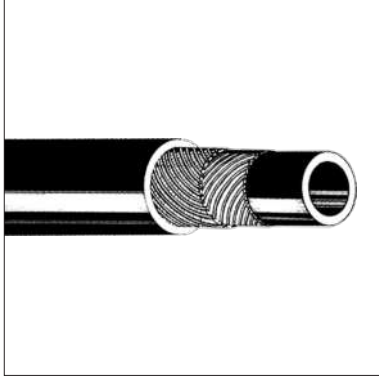

Product Code		Dimensions				Working Pressure	Bend Radius	Weight
		Inside Dia.		Wall	O.D.			
7 meter spool	30 meter spool	mm	ins	mm	mm	bar	mm	g/m
P3111048	P3111048-R	4.8	3/16	3.0	10.8	3.4	15	110
P3111063	P3111063-R	6.3	1/4	3.2	12.7	3.4	20	140
P3111079	P3111079-R	7.9	5/16	3.4	14.7	3.4	25	160
P3111095	P3111095-R	9.5	3/8	3.6	16.7	3.4	40	210
	P3111127-R	12.7	1/2	3.8	20.3	2.4	50	257

- Designed to carry automotive fuel
- Nitrile inner liner
- Outer cover CR (Neoprene)
- Temperature range from -30° C to +100° C
- Dual spiral wrap reinforcement
- Conforms to SAE 30 R6
- Safety factor of 5:1.
- Hose is suitable for unleaded petrol (up to 98 Octane) and diesel
- Hose is **not suitable for submersion** in tank
- Hose is not suitable for ethanol blends of petrol or bio diesel

P311T

AUTO
TRANSMISSION COOLER HOSE

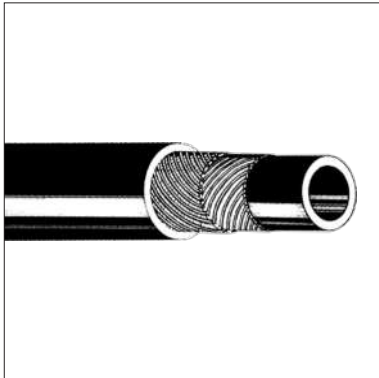

Product Code		Dimensions				Working Pressure	Bend Radius	Weight
		Inside Dia.		Wall	O.D.			
7 meter spool	30 meter spool	mm	ins	mm	mm	bar	mm	g/m
P311T079	P311T079-R	7.9	5/16	3.4	14.7	12	25	160
P311T095	P311T095-R	9.5	3/8	3.6	16.7	12	40	210

- For use with modern automatic transmissions
- Nitrile inner liner
- Polyester reinforcement
- Neoprene cover resistant to oil, fuel and heat
- Temperature range from -40° C to +135° C
- Manufactured to SAE 30 R6 Specification

AUTOMOTIVE HOSES

PACKAGED SPOOLS
FOR WORKSHOP & HOME

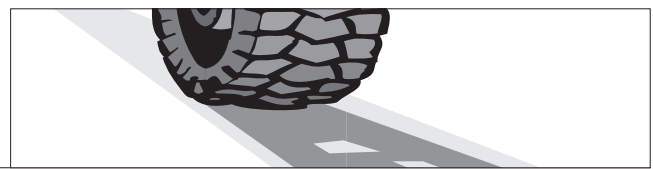

P3300

AUTO
VACUUM AND WASHER HOSE

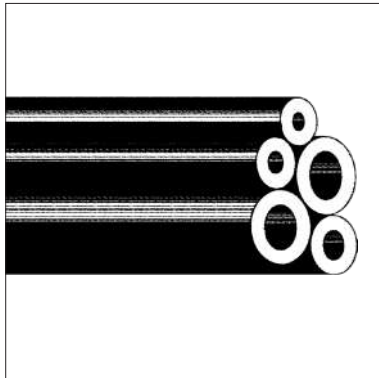

Product Code		Dimensions						
		Inside Dia.		Wall	O.D.			
15 meter spool		mm	ins	mm	mm			
P3300025		2.5	7/64	2	6.5			
P3300030		3.0	1/8	2	7.0			
P3300040		4.0	5/32	2	8.0			
P3300045		4.5	11/64	2	8.5			
P3300055		5.5	7/32	2	10.0			
P3300063		6.3	1/4	2	10.5			

- For use in windscreen washer systems and vacuum operated controls
- Manufactured from EPDM rubber
- Withstands the pressure exerted by windscreen washer systems and control system vacuum
- Heat and weather resistant
- Manufactured to SAE-J-200 Specification

P3300

AUTO
RADIATOR OVERFLOW HOSE

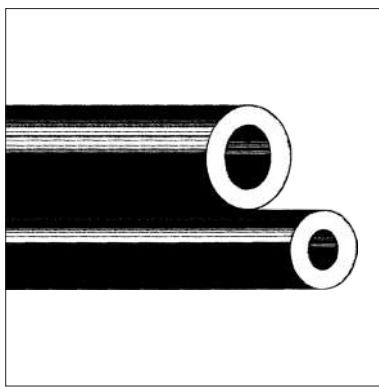

Product Code		Dimensions						
		Inside Dia.		Wall	O.D.			
15 meter spool		mm	ins	mm	mm			
P3300079		8	5/16	2	12			
P3300095		10	3/8	2	14			

- Suitable for radiator overflow and header tank applications
- Manufactured from EPDM rubber
- Withstand radiator temperatures and pressures as well as vacuum
- Weather, oil and radiator additive resistant

P4205

AUTO
BRAKE VACUUM HOSE

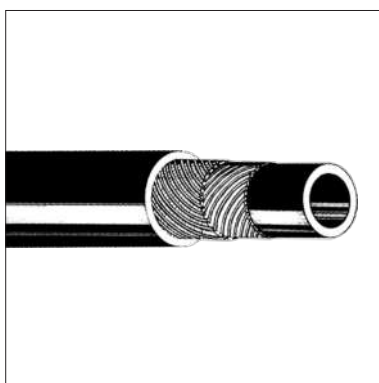

Product Code		Dimensions				Vacuum	Bend Radius	Weight
		Inside Dia.		Wall	O.D.			
7 mete spool	30 meter spool	mm	ins	mm	mm	bar	mm	g/m
P4205095	P4205095-R	9.5	11/32	4	17.5	0.87	30	252
P4205120	P4205120-R	12.5	1/2	4	20.0	0.87	40	299

- Designed to transmit manifold vacuum in automotive power assisted braking systems.
- Neoprene liner and cover
- Rayon reinforcement
- Conforms to SAE J 1403
- Resistant to oil, petrol, heat and weather

AUTOMOTIVE HOSES

PACKAGED SPOOLS
FOR WORKSHOP & HOME



P4801

AUTO
HEATER HOSE

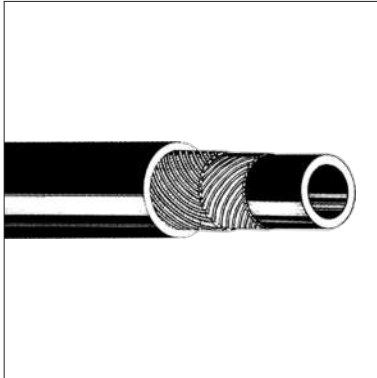

Product Code		Dimensions			Working Pressure	Bend Radius	Weight	
		Inside Dia.	Wall	O.D.				
15 meter spool	50 meter spool	mm	ins	mm	mm	bar	mm	g/m
	P4801095-R *	9.5	3/8	3.75	17.0	10	50	220
P4801127	P4801127-R	12.7	1/2	3.40	19.5	10	50	240
P4801160	P4801160-R	16.0	5/8	3.40	22.8	10	80	290
P4801191	P4801191-R	19.0	3/4	3.60	26.3	10	100	360

* 25 meter roll length in this size

- Developed for vehicle coolant systems
- Safety factor of 3:1
- Temperature range of -40° C to +100° C
- Made from a rubber and EPDM blend
- Reinforced with a double braid spiral wrap
- Conforms to SAE 20 R3
- Weather resistant
- Impervious to coolant system additives
- Not suitable for use with petrochemical products

P5130

AUTO
POWER STEERING RETURN HOSE

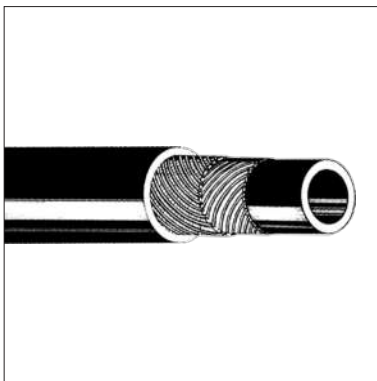

Product Code		Dimensions			Working Pressure	Bend Radius	Weight	
		Inside Dia.	Wall	O.D.				
7 meter spool	30 meter spool	mm	ins	mm	mm	bar	mm	g/m
P5130079	P5130079-R	7.9	5/16	4.0	16.0	17.2	25.0	224
P5130100	P5130100-R	10	3/8	4.0	18.0	17.2	40.0	242

- Designed specifically as low pressure side return hose for vehicle power steering systems
- Nitrile inner liner
- Polyester double braid reinforcement
- Neoprene cover
- Resistant to oil, fuel and heat
- Operating temperature range is -40° C to +121° C
- Safety factor of 4:1
- Conforms to SAE J 189 Specification

PH533

AUTO
EFI FUEL INJECTION HOSE

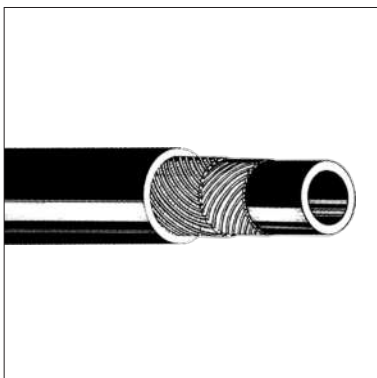

Product Code		Dimensions			Working Pressure	Bend Radius	Weight	
		Inside Dia.	Wall	O.D.				
7 meter spool		mm	ins	mm	mm	bar	mm	g/m
PH533079		7.9	5/16	3.05	14	6.9	25	155

- A high performance fuel injection hose designed to run at higher pressures and temperatures than normal fuel injection hoses.
- NBR/FKM inner tube
- CSM cover
- Conforms to SAE J30 R9 Specifications

AUTOMOTIVE HOSES

PACKAGED SPOOLS
FOR WORKSHOP & HOME

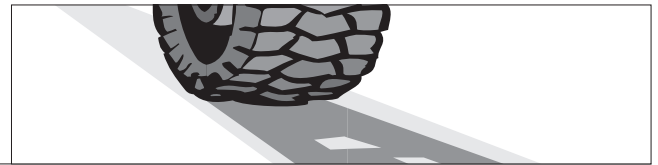

PCH-A

AUTO GENERAL HOSE MERCHANDISER

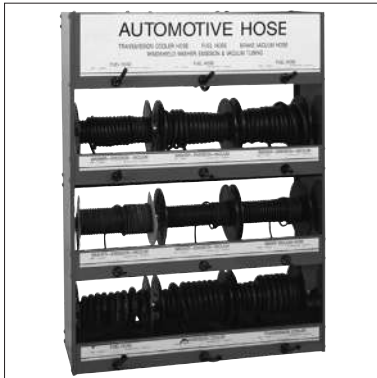

PCH-A General Hose Merchandiser							
Qty	Pack	Product Code	Description	Inside Diameter		Length	Page
				mm	ins		
1	Spool	P4205095	Brake Vacuum	9.5	11/32	7	69
1	Spool	P311T079	Transmission Cooler	7.9	5/16	7	68
1	Spool	P3111048	Fuel	4.8	3/16	7	68
1	Spool	P3111063	Fuel	6.3	1/4	7	68
1	Spool	P3111079	Fuel	7.9	5/16	7	68
1	Spool	P3111095	Fuel	9.5	3/8	7	68
1	Spool	P3300025	Vacuum & Washer	2.5	7/64	15	69
1	Spool	P3300030	Vacuum & Washer	3.0	1/8	15	69
1	Spool	P3300040	Vacuum & Washer	4.0	5/32	15	69
1	Spool	P3300055	Vacuum & Washer	5.5	7/32	15	69
1	Spool	P3300063	Vacuum & Washer	6.3	1/4	15	69
1	Spool	PH533079	Fuel Injection Hose	7.9	5/16	7	70

- A robustly made powder coated steel cabinet designed to hold 12 spools of hose
- Can be displayed as a free standing unit or mounted to the wall.
- Features metric and imperial measuring scales
- Allows front loading of stock
- Hose type and sizing is clearly marked
- Dimensions (mm): W x H x D 720 x 970 x 220

PCH-B

AUTO HEATER HOSE MERCHANDISER

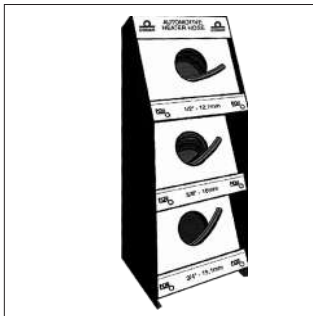

PCH-B Heater Hose Merchandiser							
Qty	Pack	Product Code	Description	Inside Diameter		Length	Page
				mm	ins		
2	Spool	P4801127	Heater Hose	12.7	1/2	15	70
2	Spool	P4801160	Heater Hose	16	5/8	15	70
2	Spool	P4801191	Heater Hose	19	3/4	15	70

- A robustly made powder coated steel cabinet designed to hold 3 popular sizes of heater hose
- Free standing unit
- Features metric and imperial measuring scales
- Allows front loading of stock
- Hose type and sizing is clearly marked
- Dimensions (mm): W x H x D 480 x 1200 x 430

TPHC (Replaces 4523)

HAND CUTTER SUIT AUTO AND AIR CON HOSES, THERMOPLASTIC, NYLON & FABRIC BRAID RUBBER & PVC HOSE



Hand Cutting Tool	
Product Code	Description
TPHC-001	Hand Cutter for Hose and Tube - Up to 28mm External Diameter
TPHCRB - 001	Replacement Blade for Hand Cutter

- A robustly made hand cutting tool for cleanly cutting a wide range of hose and tube products
- Replaceable blade

AIR CONDITIONING ASSEMBLIES



ACH AUTO AIR CONDITIONING HOSE (REDUCED BARRIER)



Product Code	Dimensions			Inside Diameter mm		Outside Diameter mm		Weight
	Dash Size	Nominal Dia.		min	max	min	max	Kg/m
		mm	ins					
ACH-06	6	8	5/16	7.9	8.6	14.2	15.2	0.13
ACH-08	8	10	13/32	10.4	11.2	16.8	17.8	0.18
ACH-10	10	12	1/2	12.5	13.5	18.9	19.9	0.19
ACH-12	12	16	5/8	15.6	16.6	23.1	24.1	0.30

Specifications

- Chloroprene blend tube compound
- Extruded polyamide barrier for low permeation
- Single braid polyester reinforcement
- Chlorobutyl cover compound for low moisture ingress
- Permeation: 2.3- 2.6 Kg/m²/yr (tested at 80°C)
- Moisture Ingression: 0.033g/cm²/yr
- Temperature Range of -40°C to +135°C
- Meets SAE J2064 Type C Class I

Features

- Light weight and flexible for easy routing
- Compatible with R134a and many other vehicular refrigerants
- Compatible with PAG (Polyalkylene glycol) oil and other popular lubricants

ACW AUTO AIR CONDITIONING WELD ON HOSE TAILS (LIFE SAVERS)



Product Code	Fitting Type	Tube Size	Hose Tail Size	
			Dash	Actual
Aluminium Tails				
ACWA1-0606	Fitting only	3/8"	06	5/16"
ACWA1-0606RB	One piece (fitting & ferrule)	3/8"	06	5/16"
ACWA1-0808	Fitting only	1/2"	08	13/32"
ACWA1-0808RB	One piece (fitting & ferrule)	1/2"	08	13/32"
ACWA1-0810	Fitting only	1/2"	10	1/2"
ACWA1-1010	Fitting only	5/8"	10	1/2"
ACWA1-1010RB	One piece (fitting & ferrule)	5/8"	10	1/2"
ACWA1-1210	Fitting only	3/4"	12	1/2"
ACWA1-1212	Fitting only	3/4"	12	5/8"
ACWA1-1212RB	One piece (fitting & ferrule)	3/4"	12	5/8"
Steel Tails				
ACWS1-0606	Fitting only	3/8"	06	5/16"
ACWS1-0606RB	One piece (fitting & ferrule)	3/8"	06	5/16"
ACWS1-0808	Fitting only	1/2"	08	13/32"
ACWS1-0808RB	One piece (fitting & ferrule)	1/2"	08	13/32"
ACWS1-1010	Fitting only	5/8"	10	1/2"
ACWS1-1010RB	One piece (fitting & ferrule)	5/8"	10	1/2"
ACWS1-1212	Fitting only	3/4"	12	5/8"
ACWS1-1212RB	One piece (fitting & ferrule)	3/4"	12	5/8"

ACF* FERRULES TO SUIT REDUCED BARRIER AIR CONDITIONING HOSE



Product Code	Description
ACF-06	Steel ferrule to suit 5/16" ACH Air Con hose
ACF-08	Steel ferrule to suit 13/32" ACH Air Con hose
ACF-10	Steel ferrule to suit 1/2" ACH Air Con hose
ACF-12	Steel ferrule to suit 5/8" ACH Air Con hose

Use hydraulic ratchet crimping tool (beadlock / bubble style) with reduced barrier crimp dies.
(Refer to Pirtek Assembly Procedure Document WI-0902-34)

AIR CONDITIONING ASSEMBLIES



ACABR AUTO AIR CONDITIONING ALUMINIUM BRAZING RODS



Product Code	Description
ACABR	Pack of 25 Aluminium brazing rods with flux core

Application

Used to braze Aluminium Weld-On tails to Air Con Tube

ACNBL AUTO AIR CONDITIONING LUBRICANT / SEALANT



Product Code	Description
ACNBL	30 ml Nylog Blue Lubricant / Sealant

Specifications

- a synthetic refrigeration oil
- compatible with mixtures of POE (Polyester oil), PAG, mineral and alkyl benzene oils in the presence of HFC-134a, cross blends of CFC and HCFC refrigerants as well as R-410a in POE and PVE (Polyvinylether) lubricants

Features

- Non-hardening, non-drying fluid
- bonds tenaciously to many different substrates
- acts as a gasket thread sealant and assembly lube
- Can be used universally or specifically with an HFC bound synthetic oil system

ACOR AUTO AIR CONDITIONING O-RINGS

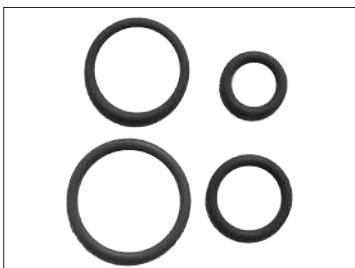

Product Code	Description
ACOR-6	Air Con O-ring HNBR Green suits -06 (3/8") size
ACOR-8	Air Con O-ring HNBR Green suits -08 (1/2") size
ACOR-10	Air Con O-ring HNBR Green suits -10 (5/8") size
ACOR-12	Air Con O-ring HNBR Green suits -12 (3/4") size

Specifications

- HNBR (Hydrogenated Nitrile Butadiene Rubber)
- good physical strength and retention properties after long term exposure to oil, heat & chemicals.

Features

- HNBR Green O-rings are used in valves / ports of air conditioning components and hose assemblies.

DEF / ADBLUE TUBE & FITTINGS

DEF/SCR TUBE



Multilayer nylon tube made of ETFE/PA12. These tubes have excellent performance for corrosion resistance and low Urea solution permeation. They meet the requirements of SAE J84
Temperature range: -60°C to +125°C
Vacuum upto 20inHG

Part Number	Size mm (ID x OD)"	Working Pressure (PSI)"	Burst Pressure (PSI)"	Bend Radius (mm)"
DEFMPET-03	3 x 5	250	1203	30
DEFMPET-06	6 x 8	250	1000	42

COUPLER FITTINGS

Quick connect fittings in accordance with SAEJ2044
Operating pressure 5-7bar (72-101PSI), Occasional peaks upto 11bar (160PSI)
Operating vacuum 0.55bar (-7.2 PSI) (16inHG)
Operating temperature: -40°C to + 120°C (Occasional peaks to +150°C)
All Quick connect couplers supplied with dust plug.

DEFSFQC1 QUICK CONNECT COUPLER STRAIGHT

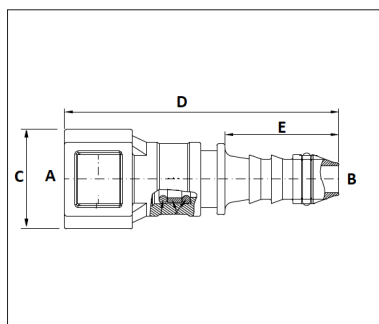

Product Code	A	B (suit tube)	C (mm)	D (mm)	E (mm)
DEFSFQC1-0403	1/4" (6.30)	3x5mm	18.0	44	14
DEFSFQC1-0406	1/4" (6.30)	6X8MM	18.0	50.5	21.0
DEFSFQC1-0506	5/16" (7.89)	6x8mm	20.5	52	19.1
DEFSFQC1-0606	3/8" (9.49)	6x8mm	23.9	50.7	21.0

*DEFSFQC1-0606 size incorporates an o-ring on the tail.

DEFSFQC9 QUICKCONNECT COUPLER 90°

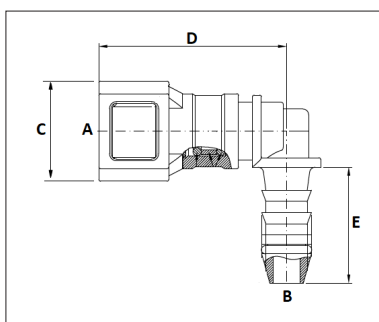

Product Code	A	B (suit tube)	C (mm)	D (mm)	E (mm)
DEFSFQC9-0403	1/4" (6.30)	3X5MM	18.00	31.2	14.0
DEFSFQC9-0406	1/4" (6.30)	6X8MM	18.0	33.6	20.5
DEFSFQC9-0506	5/16" (7.89)	6X8MM	20.5	32.0	19.1
DEFSFQC9-0606	3/8" (9.49)	6X8MM	23.9	32.0	21.0

*DEFSFQC9-0606 size incorporates an o-ring on the tail.

DEF / ADBLUE TUBE & FITTINGS

DEFSMDP DUST PLUG TO SUIT QUICK CONNECT COUPLER

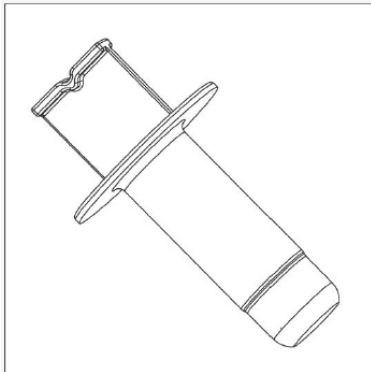

Product Code	Suit Coupler
DEFSMDP-04	1 /4" (6.30)
DEFSMDP-05	5/16" (7.89)
DEFSMDP-06	3/8" (9.49)

DEFSME1 QUICK CONNECT MALE END/PROBE STRAIGHT

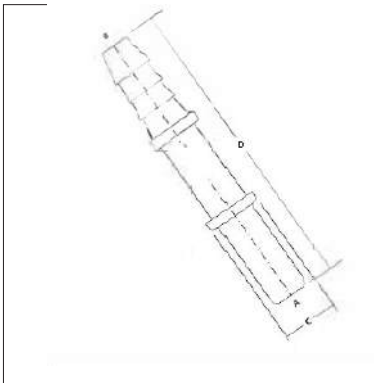

Product Code	A	B (suit tube)	C (mm)	D (mm)
DEFSME1-0506	5/16" (7.89)	6x8mm	10.9	60.0

DEFTOOL-S ASSEMBLY TOOL KIT FOR DEF TUBE & FITTINGS



Product Code	Kit contents
DEFTOOL-S	1 x Base plate with pusher & lever
	1 x lever extension
	1 x tubing clamp suit 3x5mm & 6x8mm tube
	2 x pusher inserts suit 3x5mm & 6x8mm tails
	2 x supports for 90° fittings

Easy & convenient kit for assembling DEF fittings into tube.
No need to place the plastic fittings into a vice which can potentially break the fitting.
Ensures that the fitting & tube is correctly assembled.

CABLE TIES

INCLUDING STAINLESS STEEL TIES AND INSTALLATION GUNS

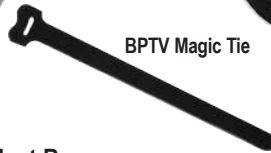

Recommended cable tie / flush cutter snips
Product Code: PCTC

Description :

- All Nylon one piece construction
- Min. loop tensile strength ranging from 8.1kg to a maximum of up to 114kg.
- Cable Ties use UL approved Nylon 6/6 with flamability rating of UL94V-2
- Approved to the requirements of MILITARY 3367 - 1978 and UL Underwriters Laboratories E156597
- Temperature range: - 40°C to + 85°C

Product Range:

- Individual packs
- Mixed pack
- Merchandiser tree
- Also in Stainless Steel and as Velcro® Magic Ties

Applications:

- A common and useful product for location of hoses in their operating environment
- Use to secure and restrain hose movement to avoid damage through abrasion
- Ideal for urgent small repairs or bundling automotive hoses or electrical cables
- Always take care when using cable ties - consider the application carefully and heed sound installation guidelines. Consult Technical Section A for a guide to installation of hydraulic hoses

INDIVIDUAL PACKS					
Product Code Cable Ties			Pack Quantity	Dimensions mm	Min. Loop Tensile Strength Kg
Nylon	304 St. Steel	Magic Ties			
BPT10025			100	100mm x 2.5mm	8.1
BPT15235			100	150mm x 3.5mm	18.2
	BPTS20046		100	200mm x 4.6mm	
BPT20247 *			100	200mm x 4.8mm	22.2
	BPTS20080		100	200mm x 8.0mm	
		BPTV20016	5	200mm x 16mm	
BPT30148 *			100	300mm x 4.8mm	22.2
		BPTV30016	5	300mm x 16mm	
	BPTS36046		100	360mm x 4.6mm	
	BPTS36080		100	360mm x 8.0mm	
BPT38275			100	368mm x 7.6mm	54.4
BPT38348			100	370mm x 4.8mm	22.2
BPT43090			100	430mm x 9.0mm	79.4
BPT53390			100	533mm x 8.0mm	79.4
BPT55013			100	580mm x 13mm	114.0
BPT76290			100	760mm x 9.0mm	79.4
BPT83090			100	830mm x 9.0mm	79.4
BPT102090			100	1020mm x 9.0mm	79.4
BPT122090			100	1220mm x 9.0mm	79.4

BPTVR Velcro® One Wrap	
Product Code	Roll Detail
BPTVR12	23m x 12mm
BPTVR19	23m x 19mm
BPTVR25	23m x 25mm

AUDIT CABLE TIES



- Colour coded individually serial numbered cable ties
- Nylon 6 one piece construction
- Flammability rating of UL94V2 with a melting point of 215°C
- Ideal for applying to mobile or fixed point machinery, hose assemblies & pipe/ tube for audit identification & risk classification.

AUDIT CABLE TIES			
Product Code	Pack Qty	Dimensions (mm)	Colour
BPAT30050G	20	300 x 5.0	Green
BPAT30050O	20	300 x 5.0	Orange
BPAT30050R	20	300 x 5.0	Red

* Also available in blue, green, red or yellow. Add BL, G, R, or Y Suffix to Product Code

CABLE TIE INSTALLATION GUNS	
Product Code	Quantity
BPPCTG-4.8	H. Duty Plastic Gun Adjustable Tension, Auto Cutting. Cuts: 2.5 – 4.8mm Wide Cable Ties
BPPCTG-9.0	Metal Gun Adjustable Tension, Auto Cutting Action. Cuts 2.5 – 9.0mm Wide Cable Ties
BPSTG-7.9	Stainless Steel Gun Tightens & Auto cuts with Adjustable Pressure. Tie Thickness – 0.3mm width to 7.9mm

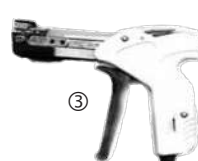

STAINLESS STEEL CRIMP RINGS

304 GRADE STAINLESS STEEL



Circular rings used to secure Diffusion Abrasion Sleeve (DAS) along with fire sleeve and braided stainless steel sleeve. Can also be used on low pressure PVC & rubber textile braided hoses in replace of hose clamps.

"Product Code"	Dimensions (mm)		
	"ID (mm)"	"OD (mm)"	"Width (mm)"
CR-025	25	28	25
CR-029	29	32	25
CR-031	31	34	30
CR-039	39	42	30
CR-048	48	51	30
CR-057	57	60	30
CR-072	72	76	35
CR-085	85	89	35
CR-098	98	102	40
CR-104	104	108	40

3981

BRASS FERRULES FOR LOW PRESSURE HOSES

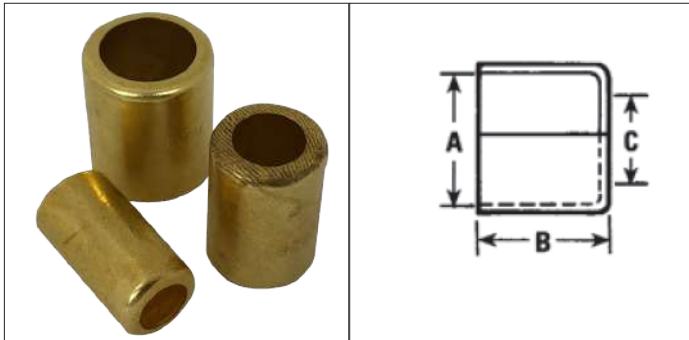

Product Code	"ID (mm) A"	"Length (mm) B"	"ID (mm) C"
3981-04	12.7	25.4	8.6
3981-05	13.5	12.0	9.4
3981-06	16.6	25.4	11.1
3981-08	20.6	25.4	16.0

TEST TAGS

STAINLESS STEEL ID TAGS & DISC



Used to record hose assembly and testing information, then attach to hose. NAVY tag conforms to the requirements of the NAVY Technical Directive. Discs ideal for attaching onto hose assemblies and equipment. All tags can be secured using Pirtek 4.6mm S/S cable ties.

"Product Code"	Dimensions (mm)			
	Length	Width	Thickness	Hole ID
TEST TAG	130	20	0.5	4.9
NAVY TAG	150	20	0.6	4.9
TEST DISC	24.9 (OD)	-	1.2	4.9

HOSE CLEANING GUNS, PROJECTILES & KITS

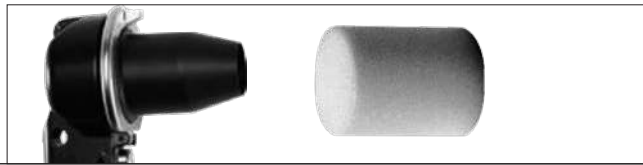

IMPORTANT USAGE NOTE:
Hoses must be cleaned FROM BOTH ENDS by use of the appropriate pellet BEFORE installing the fittings

Description:

The Pirtek hose cleaning kit is the ideal choice for high volume cleaning of hydraulic pipes and hoses, as well as dry and liquid flow lines. The unit shoots oversized foam projectiles to clean straight, curved and coiled tubes, pipes and hoses 3/16"-2" (4.8-51mm) I.D. A hinged nozzle housing allows rapid loading of projectiles for fast throughput of large cleaning jobs

Mobile Solution:

For applications where larger hose and tube sizes are not encountered, a smaller kit catering for sizes up to 1.1/4" is available

Special Situations:

A wide range of special projectiles are available to special order for special situations

Examples include:

Abrasive: Hose, tube or pipe with build up of contamination, surface rust or scale.

Grinding: Straight lengths of tube or pipe with greater build up of contamination, surface rust or scale

PIRTEK CLEANING KITS - Comes in lockable, sturdy carry case & quick connect air couplings	
Product Code	Description
VKIT	Cleaning of hose, tube & pipe range between 5mm to 32mm (3/16" to 1.1/4") 8 x hose (white) nozzles, 12 x Tube/JIC (green) nozzles. AM-1 hand piece.
FKIT	Cleaning of hose, tube & pipe range between 5mm to 50mm (3/16" to 2") 10 x hose (white) nozzles, 14 x Tube/JIC (green) nozzles. A-2 hand piece.

REPLACEMENT PARTS	
Product Code	Description
PJ-32H	32mm launcher head for nozzles up to 32mm. Suits AM-1 hand piece
PJ-HA1	AM-1 hand piece
PJ-50H	50mm launcher head, comes with adaptor ring to suit smaller nozzles. Suits A-2 hand piece
PJ-AR	Adaptor ring suit PJ-50H launcher head for nozzles up to 32mm
PJ-HA2	A-2 hand piece
PJ-HN06	Nozzle (white) suits 1/4" hose
PJ-HN08	Nozzle (white) suits 5/16" hose
PJ-HN10	Nozzle (white) suits 3/8" hose
PJ-HN13	Nozzle (white) suits 1/2" hose
PJ-HN16	Nozzle (white) suits 5/8" hose
PJ-HN19	Nozzle (white) suits 3/4" hose
PJ-HN25	Nozzle (white) suits 1" hose
PJ-HN32	Nozzle (white) suits 1.1/4" hose
PJ-HN38	Nozzle (white) suits 1.1/2" hose
PJ-HN50	Nozzle (white) suits 2" hose



Launcherhead(PJ-50Hshown)

Adaptor ring



Hand piece (PJ-HA1 shown)



Hose Nozzle

STANDARD HOSE PELLETS				
Product Code	Description	Qty per Bag	Suits Pipe ID	Suits Hose ID
			mm	ins
PJS-007	STANDARD PELLET - 7 mm	300	6	1/4"
PJS-010	STANDARD PELLET - 10 mm	300	8	5/16"
PJS-012	STANDARD PELLET - 12 mm	300	10	3/8"
PJS-016	STANDARD PELLET - 16 mm	300	13	1/2"
PJS-020	STANDARD PELLET - 20 mm	300	16	5/8"
PJS-022	STANDARD PELLET - 22 mm	300	19	3/4"
PJS-033	STANDARD PELLET - 33 mm	50	25	1"
PJS-040	STANDARD PELLET - 40 mm	50	32	1.1/4"
PJS-050	STANDARD PELLET - 50 mm	40	38	1.1/2"
PJS-060	STANDARD PELLET - 60 mm	30	50	2"
PJS-070	STANDARD PELLET - 70 mm	10	63	2.1/2"
PJS-075	STANDARD PELLET - 75 mm	10	70	
PJS-085	STANDARD PELLET - 85 mm	10	80	3"



This page is part of a complete catalogue containing technical and safety data. All data must be reviewed when selecting a product. Pirtek reserve the right to change technical specifications without notice.

THREAD IDENTIFICATION AND TOOL KITS



TIK THREAD IDENTIFICATION KIT

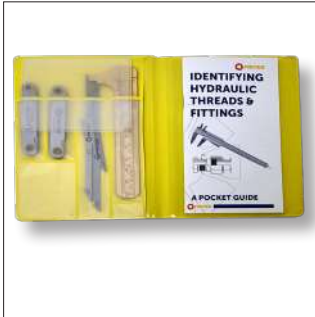

Description

- An all-in-one solution that addresses the need for a simplified guide to identifying the wide range of hydraulic fittings in common use world wide

Advantages

- Most kits simply list the various fitting types and give a run-down on their identifying characteristics. With these, identifying an unfamiliar thread involves searching through page after page of technical data.
- Pirtek's Kit adopts a more logical approach. Simply choose which picture(s) most closely resemble the unknown fitting, and you will be directed to a small selection of fittings that represent the most likely candidates, along with the page numbers on which they appear in detail.

Contents

- The Tools You Need
- 3 Steps to Success
- Pictorial Guides
- BSP / JIC / UNO
- SAE / NPT / ORFS
- Flanges
- Metric Ports & Studs
- Metric Compression
- Millimetric / GAZ
- Metric Face Seal (Chinese)
- JIS Metric & BSP
- Banjos Metric & BSP
- Staplelok / Super Staplelok
- SKV / SSKV
- Handy Tips / Variations

TIK-DIG THREAD ID DIGITAL TOOL KIT



Description:

- The Branded Measuring Kit "TIK-DIG" will increase the awareness of Pirtek among the customers circle and will distinguish the product from the competition.

Contents:

- Digital Vernier (incl battery)
- Steel Ruler 6"
- Metric and Imperial Identifier Tool
- Angle Gauge
- Thread Identification Booklet

VTSMTS 5 PIECE MAGNETIC TOOL SET



Description:

- A handy tool kit for home, workshops and mobile service vehicles.
- helps find and hold parts and tools, keeping them handy and organised

Contents:

- 450mm long magnetic tool bar
- Magnetic extendable pocket clip pick up pen
- Magnetic extendable flexible tip pick up tool with LED light
- 150mm diameter magnetic round tray
- 150mm x 250mm magnetic rectangle tray

Specification:

- 430 grade Stainless Steel magnetic tool trays
- the round tray has 1 magnet of magnetic field intensity 1000-1200 gauss
- the rectangle tray has 2 magnets of 1000-1200 gauss each
- the pick-up tool with LED has 6 LED lights and can lift up to 1.4kg. It requires 4 batteries LR 44 (batteries included)
- the 450mm bar can hold up to 12kg of items
- the pocket clip pick up pen can lift up to 0.4kg

THREAD IDENTIFICATION AND TOOL KITS



VTSOHP

2 PIECE O-RING HOOK AND PICK TOOL SET



Product Code	Description
VTSOHP	2 Piece O-Ring Hook and Pick Tool Set

Description:

- 2 ideal tools for facilitating the removal and installation of o-rings, seals & washers

Safety Caution:

Always wear eye protection to prevent personal injury

Specification:

- knurled handle design to ensure positive grip is made from aluminium alloy
- the metal rods are made of S2 alloy steel with tip hardness of between 58-62 Rockwell C

Spill Plugs



Description

Specially designed to prevent spillage, leakage and contamination of various fluids on hoses, tubes and machinery. Available in 3 different sizes, the conical shape rubber is designed to effectively seal various sized ports during maintenance, service or storage of equipment and machinery. Widely used in applications including hydraulic maintenance, heavy equipment, mining, automotive, transportation, offshore, marine, defence industries, agriculture and many more.

- * Easy to use; Insert, Push & Twist
- * Prevents spills & stops leaks, protecting the environment
- * Protects against ingress of dust, dirt, moisture & contaminants
- * Resistant to most oils, chemicals & liquids
- * Temperature range: -25°C to +90°C (-13°F to +194°F)
- * Excellent UV resistance
- * Does not contain Silicon
- * Yellow colour for easy identification
- * Not to be used under pressure

Product Code	Description	Qty/Pack
SPLUG-S	Small Plugs suits hole dia. 1mm-13mm (3/64"-1/2")	20
SPLUG-M	Medium Plugs suits hole dia. 8mm-26mm (5/16"-1")	10
SPLUG-L	Large Plugs suits hole dia. 12mm-38mm (1/2"-1.1/2")	4
SPLUG-MIX	Mixed pack, 4 x Small, 4 x Medium, 2 x Large	10



PRESSURE WASHERS

GUNS, NOZZLES & COUPLINGS

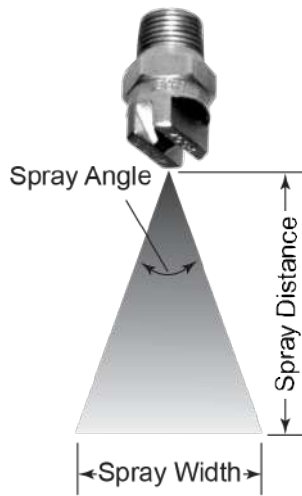
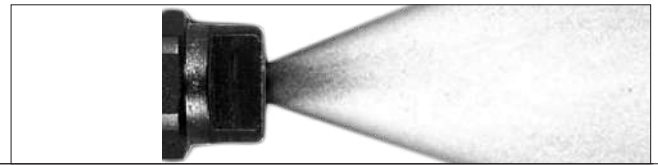

SPRAY WIDTH TABLE (THEORETICAL COVERAGE)

Spray Distance	Nozzle Spray Angle						
	5°	15°	25°	40°	65°	80°	110°
100	9	26	44	73	127	168	286
125	11	33	55	91	159	219	357
160	14	42	71	116	204	268	457
200	18	52	86	146	255	336	571
250	22	66	111	182	319	420	714
315	27	83	140	229	401	529	900
400	35	105	177	291	510	671	1143
500	44	132	222	364	637	839	1428
630	54	166	279	459	803	1057	1799
800	70	211	355	582	1019	1343	2285
1000	90	260	440	730	1270	1680	2860

All measurements in mm

TABLE OF RECOMMENDED FLOW RATES (LITRES / MINUTE) FOR DIFFERENT PRESSURES AND NOZZLE SIZES †

Nozzle Ø mm	Nozzle Size	Colour Code	Pressure in bar															
			20	30	40	50	60	80	100	120	150	175	200	225	250	300	400	500
1.09	0.030	White	3.1	3.7	4.3	4.8	5.2	6.0	6.7	7.3	8.2	8.9	9.5	10.0	10.5	11.6	13.4	15.0
1.19	0.040	Dk. Yellow	4.2	5.2	5.9	6.6	7.0	8.1	9.1	10.0	11.1	12.2	12.9	13.5	14.4	15.8	18.2	20.3
1.27	0.045	Blue	4.5	5.5	6.4	7.1	8.0	9.2	10.3	11.3	12.6	13.0	14.6	15.3	16.3	17.8	20.6	23.0
1.35	0.050	Lt. Purple	5.1	6.2	7.1	8.0	8.7	10.0	11.2	12.3	13.7	14.9	15.8	16.7	17.7	19.4	22.4	25.0
1.40	0.055	Dk. Red	5.6	6.8	7.8	8.7	9.8	11.3	12.6	13.8	15.4	16.7	17.8	18.8	19.9	21.8	25.2	28.2
1.47	0.060	Dk. Green	6.0	7.4	8.6	9.6	10.6	12.3	13.7	15.0	16.8	18.2	19.4	20.4	21.7	23.7	27.4	30.6
1.52	0.065	Lt. Blue	6.6	8.0	9.3	10.4	11.5	13.2	14.8	16.2	18.1	19.7	20.9	21.9	23.0	25.6	29.6	33.0
1.60	0.070	Orange	7.1	8.6	10.0	11.2	12.4	14.3	16.0	17.5	19.6	21.2	22.6	23.8	25.3	27.7	32.0	35.8
1.65	0.075		7.6	9.3	10.7	12.0	13.1	15.2	16.9	18.5	20.7	22.4	23.9	25.3	26.7	29.4	33.7	37.7
1.70	0.080	Silver	8.0	9.8	11.3	12.7	14.1	16.3	18.2	19.9	22.3	24.1	25.7	27.0	28.8	31.5	36.4	40.7
1.75	0.085	White Rose	8.5	10.4	12.1	13.5	15.0	17.4	19.4	21.3	23.8	25.7	27.4	28.8	30.7	33.6	38.8	43.4
1.80	0.090	Gold	9.1	11.1	12.8	14.3	16.3	18.8	21.0	23.0	25.7	28.0	29.7	30.3	33.2	35.1	42.0	47.0
1.90	0.100	White Blue	10.0	12.3	14.2	16.0	17.8	20.6	23.0	25.2	28.2	31.0	31.8	32.5	36.4	39.8	46.0	51.4
2.34	0.150		15.1	18.5	21.3	23.9	26.1	30.2	33.8	36.9	41.3	44.6	47.7	50.5	53.3	58.7	67.2	75.2
2.69	0.200	White Red	20.1	24.7	28.5	31.9	35.6	41.1	46.0	50.4	56.3	61.0	65.1	68.3	71.1	79.7	92.0	102.9
2.99	0.250		25.2	30.9	35.1	39.8	43.6	50.4	56.4	61.8	69.1	74.6	79.8	84.6	89.2	96.0	110.0	125.0
3.30	0.300		30.2	37.0	42.7	47.8	52.4	60.5	67.6	74.0	82.8	89.4	95.6	101.0	107.0	118.0	149.0	151.0
3.56	0.350		35.3	43.2	50.0	55.8	61.1	70.5	78.9	86.4	96.6	104.0	111.0	118.0	125.0	130.0	162.0	175.0
3.81	0.400		40.3	49.4	57.0	63.7	69.8	80.7	90.2	98.8	110.0	119.0	127.0	135.0	143.0	157.0	198.0	202.2
4.24	0.500		50.5	61.6	71.4	79.8	87.4	100.9	112.9	124.0	138.0	149.0	160.0	169.0	178.0	200.0	225.0	249.0
4.65	0.600		60.5	74.2	85.6	95.7	104.9	121.1	135.4	148.0	166.0	179.0	191.0	203.0	214.0	235.0	260.0	302.0

† Tabulated values indicative only



PRESSURE WASHERS

GUNS, NOZZLES & COUPLINGS

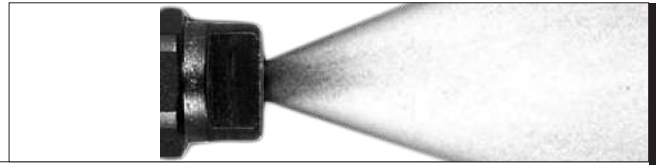

IPW-16. MEG NOZZLES - 1/4" NPT



15° Chiseling		25° Flushing		40° Wash	
Product Code	Orifice (inch)	Product Code	Orifice (inch)	Product Code	Orifice (inch)
		IPW-16.1325.25	0.025		
				IPW-16.1340.30	0.030"
IPW-16.1315.35	0.035"				
IPW-16.1315.40	0.040"				
IPW-16.1315.45	0.045"	IPW-16.1325.45	0.045"		
IPW-16.1315.50	0.050"				
		IPW-16.1325.65	0.065"		

- Stainless Steel
- Rated to 250 bar
- 1/4" NPT Male Thread
- Can be ordered as a BSPT option

IPW-21. ADJ. DETERGENT INJECTOR



Product Code	Inlet	Outlet	Nozzle	Type
IPW-21.0150.21	3/8" BSP Male	3/8" BSP Male	2.1 mm	Adjustable

- Flow Capacity 30 l/min
- Rated to 280 bar max.
- Max. Temp 90°C

IPW-25.0700 VARIABLE SPRAY HI-LO NOZZLE



Product Code	Colour Code	Orifice	Inlet	Capacity	Pressure
IPW-25.0700.14	Dark Yellow	0.040	1/4" BSP Female	40 L/min	250 bar
IPW-25.0700.15	Blue	0.045	1/4" BSP Female	40 L/min	250 bar

- Push forward for low pressure detergent injection
- Pull back for high pressure activation

PRESSURE WASHERS

GUNS, NOZZLES & COUPLINGS

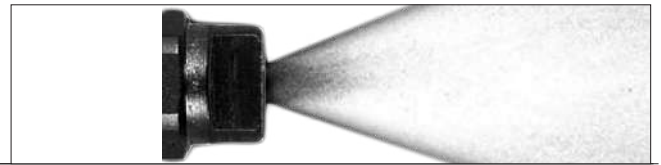

IPW-25.16xx

ROTATING TURBO NOZZLE

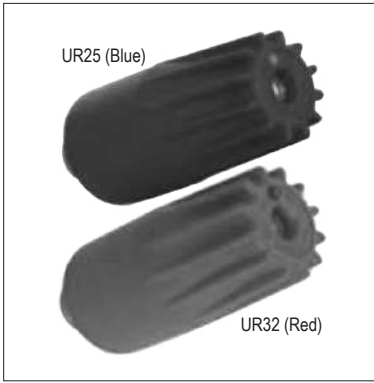

Blue UR25 (80 - 250 bar)			Red UR32 (180 - 352 bar)		
Product Code	Colour Code	Orifice (inch)	Product Code	Colour Code	Orifice (inch)
IPW-25.1620.30	White	0.030			
IPW-25.1620.35	Brown	0.035			
IPW-25.1620.40	Dark Yellow	0.040	IPW-25.1690.40	Dark Yellow	0.040
IPW-25.1620.45	Blue	0.045			
IPW-25.1620.50	Light Blue	0.050			
IPW-25.1620.55	Dark Red	0.055			
IPW-25.1620.70	Orange	0.070			

- Concentrated stream in a conical pattern
- Inlet 1/4" BSPT Female Thread

IPW-26.00xx

M22x1.5 TYPE A STANDARD NIPPLE



M22 Standard Adaptor Nipples		
Product Code	Metric Thread	BSP Thread
IPW-26.0002.31	M22 x 1.5	1/4" Fem
IPW-26.0030.31	M22 x 1.5	3/8" Male
IPW-26.0031.31	M22 x 1.5	3/8" Fem
IPW-26.0051.31	M22 x 1.5	1/4" Male

- All examples use a M22x 1.5 metric thread to take a 14 mm pin of standard length
- BSP adaptor threads as tabulated
- Suit flow rates to 40 litres / min
- Rated pressure 250 bar (max. 280 bar)

IPW-26.0250

M22 STANDARD CONNECTOR NUTS



M22 Standard Connector Nuts		
Product Code	Metric Thread	BSP Thread
IPW-26.0250.20	M22 x 1.5	1/4" Female
IPW-26.0250.30	M22 x 1.5	1/4" Male
IPW-26.0250.40	M22 x 1.5	3/8" Female
IPW-26.0250.50	M22 x 1.5	3/8" Male

- All examples use a M22x 1.5 metric thread and incorporate a 14 mm pin of standard length
- BSP adaptor threads as tabulated
- Suit flow rates to 40 litres / min
- Rated pressure 250 bar (max. 280 bar)

PRESSURE WASHERS

GUNS, NOZZLES & COUPLINGS

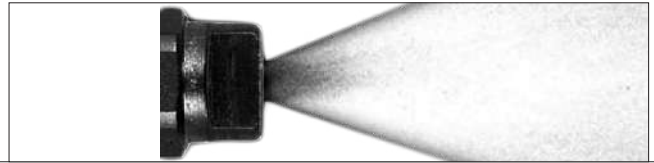

IPW-26.1032

M22x1.5 TYPE A EXTENDED NIPPLE



M22 Extended Pin Adaptor Nipples

Product Code	Metric Thread	BSP Thread
IPW-26.1032.31	M22 x 1.5	1/4" Fem

- M22x 1.5 metric thread to accommodate an extended length 14 mm pin
- 1/4" BSP female adaptor thread
- Suit flow rates to 40 litres / min
- Rated pressure 250 bar (max. 280 bar)



Extended vs Standard Nipple Length

IPW-26.1034

M22 EXTENDED CONNECTOR NUTS



M22 Standard Connector Nuts

Product Code	Metric Thread	BSP Thread
IPW-26.1034.20	M22 x 1.5	1/4" Female
IPW-26.1034.50	M22 x 1.5	1/4" Male

- M22x 1.5 metric thread incorporating a 14 mm pin of extended length
- BSP adaptor threads as tabulated
- Suit flow rates to 40 litres / min
- Rated pressure 250 bar (max. 280 bar)

IPW-26.1050

IN-LINE BRASS SWIVEL



In-Line Brass Swivel

Product Code	Inlet	Outlet
IPW-26.1050.00	3/8" BSP Male	3/8" BSP Female

- Suit flow rates to 40 litres / min
- Rated pressure 250 bar (max. 280 bar)

PRESSURE WASHERS

GUNS, NOZZLES & COUPLINGS

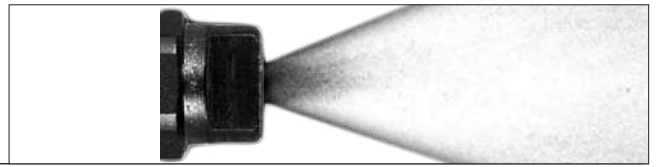

IPW-26.2010

3/8" QUICK COUPLING BODY - BSP THREAD



Product Code	BSP Thread	Material	Coupling I.D (mm)	Working Pressure
IPW-26.2010.00	3/8" Male	Nickel plated Brass	15	279 Bar
IPW-26.2010.10	3/8" Female	Nickel plated Brass	15	279 Bar
IPW-26.2010.20	1/4" Female	Nickel plated Brass	15	279 Bar

IPW-26.20xx

3/8" QUICK COUPLING PLUG - BSP THREAD



Product Code	BSP Thread	Material	Plug O.D (mm)	Working Pressure
IPW-26.2015.61	3/8" Female	Nickel plated Brass	14.8	279 Bar
IPW-26.2016.61	1/4" Female	Nickel plated Brass	14.8	279 Bar
IPW-26.2023.61	3/8" Male	Nickel plated Brass	14.8	279 Bar

IPW-28.1000

STRAINER WITH CHECK VALVE



Plastic Strainer with Check Valve		
Product Code	Hose Barb	
IPW-28.1000.30	7 mm	

- 7 mm hose barb
- Stainless steel check valve
- Plastic body

PRESSURE WASHERS

GUNS, NOZZLES & COUPLINGS

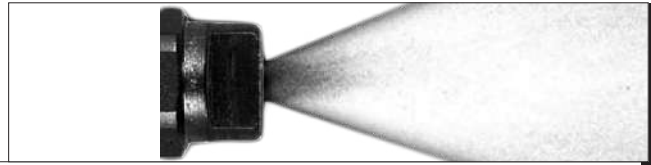

IPW-30.12xx

RL37 SPRAY GUNS



RL37 SPRAY GUNS WITH SWIVEL INLET				
Product Code	Inlet	Outlet	Pressure	Feature
IPW-30.1215.00	3/8" BSP Fem	1/4" BSP Fem	280 bar	Weep Gun †
IPW-30.1220.86	3/8" BSP Fem	1/4" BSP Fem	280 bar	-

- 3/8" BSP female swivel attachment
- Suit flow rates to 40 litres / min
- Rated pressure as tabulated
- †By Design, this gun will continue to weep even after the handle is released. This is to prevent lines in colder climates freezing up.

IPW-30.20xx

VEGA SPRAY GUNS - 4500 psi (310 Bar) max. W.P.



VEGA SPRAY GUNS			
Product Code	Inlet	Outlet	Swivel
IPW-30.2000.86	3/8" BSP Fem	1/4" BSP Fem	No
IPW-30.2030.92	3/8" BSP Fem	1/4" BSP Fem	Yes

- 3/8" BSP female attachment
- Suit flow rates to 40 litres / min
- 310 bar (4500 psi) pressure rating

IPW-30.4500

RL56 PROFESSIONAL SPRAY GUN



RL56 PROFESSIONAL SPRAY GUN			
Product Code	Inlet	Outlet	Pressure
IPW-30.4500.10	3/8" BSP Fem	1/4" BSP Fem	350 bar

- High pressure low volume gun
- Suit flow rates to 30 litres / min
- 350 bar pressure rating

PRESSURE WASHERS

GUNS, NOZZLES & COUPLINGS

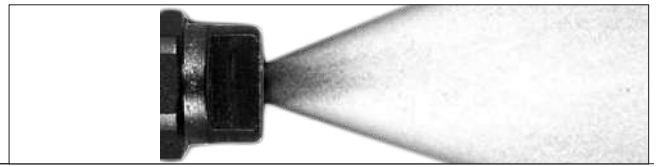

IPW-30.6425

RB65 SPRAY GUN - FOOD INDUSTRY



RB65 WASH DOWN GUN WITH SWIVEL INLET		
Product Code	Inlet Thread	Temperature
IPW-30.6425.00	1/2" BSPP Female	Up to +90°C

- Specialty gun for low pressure wash down
- Ideal in food, dairy and transit mixer applications
- adjustable flow capacity from 0-60 liters/min
- 24 bar working pressure
- Shock proof design
- Blue rubber extremities prevent breakage when dropped
- The ideal companion to Pirtek Premium Washdown Hose IRPWD

IPW-40.0370

VENTED HAND GRIP



VENTED 380 mm HAND GRIP		
Product Code	Inlet	Outlet
IPW-40.0370.00	1/4" BSP Male	1/4" BSP Female

- Flow Rate 40 litres/min
- Zinc plated steel tube
- 250 bar working pressure
- 380 mm long

IPW-40.0503

STAINLESS STEEL LANCE TUBE



Stainless Steel Lance Tube 500 mm		
Product Code	Length	Pressure
IPW-40.0503.56	500 mm	250 bar

- 1/4" BSP male threaded ends
- 40 litres/min flow capacity
- Stainless steel tube

PRESSURE WASHERS

GUNS, NOZZLES & COUPLINGS

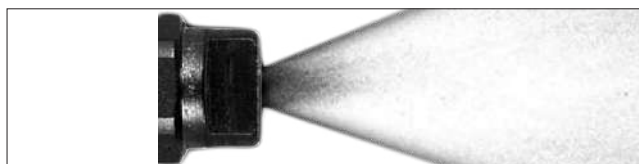

IPW-40.0965.00

S3 VENTED GRIP SPRAY LANCE



S3 VENTED GRIP SPRAY LANCE 900 mm			
Product Code	Inlet	Outlet	Pressure
IPW-40.0965.00	1/4" BSP Male	1/4" NPT Female	250 bar

- Stainless steel tube
- 40 litres/min flow capacity
- Vented plastic grip
- Complete with nozzle protector

IPW-41.0900.00

DUAL HI-LO SPRAY LANCE



DUAL HI-LO SPRAY LANCE WITH VENTED GRIP			
Product Code	Inlet	Outlet	Length
IPW-41.0900.00	1/4" BSP Male	1/4" NPT Fem	1090 mm

- Stainless Steel
- 40 litres/min flow capacity
- 250 bar working pressure
- Vented plastic grip
- Twist grip allows switching between high pressure and detergent

IPW-60.0016.60

PULSAR UNLOADER WITH GAUGE PORT - 3200 psi (220 Bar) W.P.



PULSAR 3 UNLOADER VALVE WITH PRESSURE GAUGE PORT			
Product Code	Inlet (2)	Outlet	By-Pass (2)
IPW-60.0016.60	3/8" BSP Fem	3/8" BSP Fem	3/8" BSP Fem

- Suits flow rates to 30 litres / min
- 220 bar (3200 psi) working pressure (250 bar max)
- Includes 1/4" BSP pressure gauge port
- 90°C max temperature

PRESSURE WASHERS

GUNS, NOZZLES & COUPLINGS

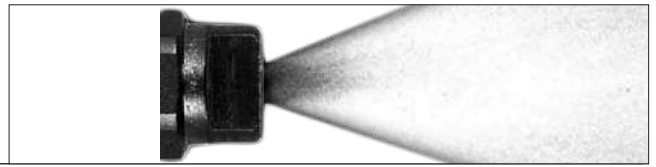

IPW-85.240.300

DETERGENT NOZZLE 1/4" NPT TO SUIT DUAL LANCE - BRASS



Brass Detergent Nozzle	
Product Code	Function
IPW-85.240.300N	Detergent

- Adds detergent in dual lance guns
- 1/4" NPT Male Thread
- Can be ordered as a BSPT option

IPW-85.300

1/4" QUICK CONNECT COUPLING BODY - NPT THREAD



Product Code	NPT Thread	Material	Coupling I.D (mm)	Working Pressure
IPW-85.300.102	1/4" Female	Brass	11.9	137 Bar
IPW-85.300.102S	1/4" Female	Stainless Steel	11.9	345 Bar
IPW-85.300.153S	1/2" Female	Stainless Steel	11.9	345 Bar

IPW-85.300

1/4" QUICK CONNECT COUPLING PLUG - NPT THREAD



Product Code	NPT Thread	Material	Coupling I.D (mm)	Working Pressure
IPW-85.300.101S	1/4" Female	Stainless Steel	11.7	345 Bar
IPW-85.300.109S	1/4" Male	Stainless Steel	11.7	345 Bar
IPW-85.300.151S	1/2" Female	Stainless Steel	11.7	345 Bar